

**NOTE:**

- \*CLIENT TO CONFIRM IF VENT GRILL TO BE USED BELOW THE WINE FRIDGE, REFRIGERATOR AND FREEZER
- \*PLUMBING IN SERVERY TO BE RELOCATED TOWARD THE CENTER OF SINK

Copyright © 2022 Pure Kitchens. All rights reserved.

<b>Job #</b>	PK24-001
<b>Client :</b>	Anthony Macri-Sixth Avenue Homes
<b>Address :</b>	35 Botfield Ave, Etobicoke, ON M9B 4E2
<b>Tel :</b>	416-278-9937
<b>Email :</b>	-
<b>Date :</b>	Oct. 30, 2023

**TOP ALIGNMENT**

<b>Bulkhead Height(B.H.)</b>	274.6 cm
<b>Cabinet Mounting Height</b>	266.0 cm

Project	Stove Wall Base & Island & Shelf & Entry Closet	Kitchen Pantry & Base Cab.	Hood & Stove Wall Panel
<b>Const.</b>	Frameless	Frameless	Frameless
<b>Door</b>	Slab	Slab	-
<b>Species</b>	AGT PET	Egger TFL	Egger TFL
<b>Grain Dir.</b>	N/A	As per drawing	-
<b>Finish</b>	Prefinished	Prefinished	Prefinished
<b>Colour</b>	Black 723 Soft Touch	H3152 ST19 Bleached Vicenza Oak	F629 ST16 Black Gold Metal Slate

<b>Interior</b>	3/4" Tafisa L203 Black TFL
<b>End Panel</b>	Flat
<b>Edge Tape</b>	match Exterior
<b>Drw.&amp;Slide</b>	Grass Vionario (Graphite) & Dynapro
<b>Toe Kick</b>	TYP.
<b>Handles</b>	Gola C Shape Profile & Gola L Shape Profile (Matte Black)

**CROWN & TRIMS**

<b>CM #</b>	Flush Fascia
<b>Bead</b>	-
<b>Baseboard #</b>	-
<b>Light Valance</b>	-

**GLASS/MIRROR & METAL**

<b>Mirror</b>	Textured (Code: -)
<b>Aluminum Frame</b>	-
<b>Metal Cladding</b>	-
<b>Light Extrusion</b>	JOYO Light LS1613 by PK

Drawn & Reviewed By	#	Revision Date
Jack X	1	2023/12/20 J.X.
Signature	Date	
Check By	2	2024/01/17 J.X.
Donny Di V	3	
Signature	Date	
Checked & Approved By Designer	4	
Jaclyn Van M	5	1:40
Signature	Date	Scale:

I have read and fully understand this Autocad drawing. The design, finishes, colour and dimensions are correct. I understand that this signed Autocad drawing will supersede any verbal or other written agreements. I understand once this drawing is signed and sent to production, no more changes may be made.

<b>Approval :</b>	Page 1 of 47
<b>Date :</b>	Kitchen

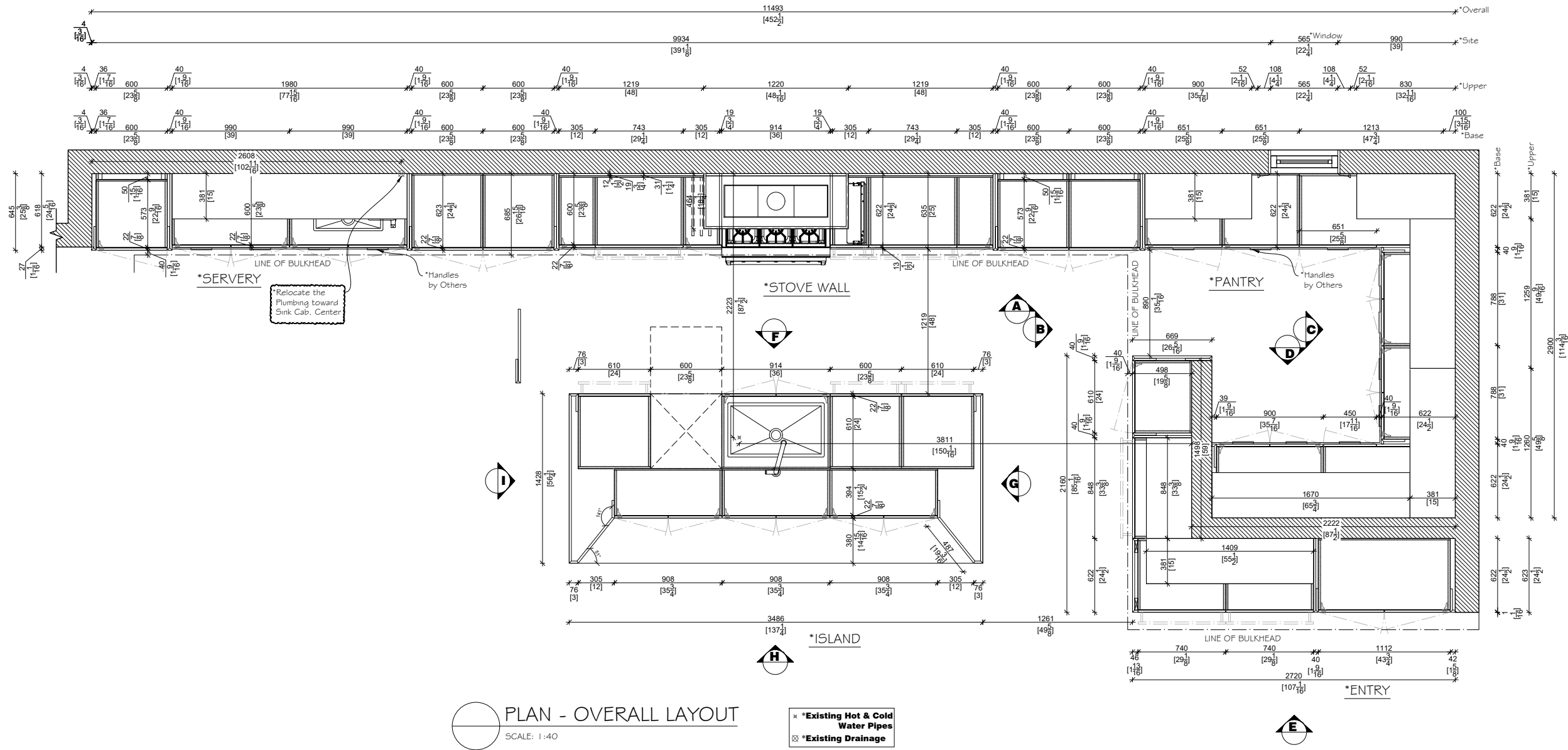

**NOTE:**

Copyright © 2022 Pure Kitchens. All rights reserved.

<b>Job #</b>	PK24-001
<b>Client :</b>	Anthony Macri-Sixth Avenue Homes
<b>Address :</b>	35 Botfield Ave, Etobicoke, ON M9B 4E2
<b>Tel :</b>	416-278-9937
<b>Email :</b>	-
<b>Date :</b>	Oct. 30, 2023

**TOP ALIGNMENT**

<b>Bulkhead Height(B.H.)</b>	274.6 cm
<b>Cabinet Mounting Height</b>	266.0 cm

Project	Stove Wall Base & Island & Shelf & Entry Closet	Kitchen Pantry & Base Cab.	Hood & Stove Wall Panel
<b>Const.</b>	Frameless	Frameless	Frameless
<b>Door</b>	Slab	Slab	-
<b>Species</b>	AGT PET	Egger TFL	Egger TFL
<b>Grain Dir.</b>	N/A	As per drawing	-
<b>Finish</b>	Prefinished	Prefinished	Prefinished
<b>Colour</b>	Black 723 Soft Touch	H3152 ST19 Bleached Vicenza Oak	F629 ST16 Black Gold Metal Slate
<b>Interior</b>	3/4" Tafisa L203 Black TFL		
<b>End Panel</b>	Flat		
<b>Edge Tape</b>	match Exterior		
<b>Drw.&amp;Slide</b>	Grass Vionaro (Graphite) & Dynapro		
<b>Toe Kick</b>	TYP.		
<b>Handles</b>	Gola C Shape Profile & Gola L Shape Profile (Matte Black)		

**CROWN & TRIMS**

<b>CM #</b>	Flush Fascia
<b>Bead</b>	-
<b>Baseboard #</b>	-
<b>Light Valance</b>	-

**GLASS/MIRROR & METAL**

<b>Mirror</b>	Textured (Code: -)
<b>Aluminum Frame</b>	-
<b>Metal Cladding</b>	-
<b>Light Extrusion</b>	JOYO Light LS1613 by PK

Drawn & Reviewed By	#	Revision Date
Jack X	1	2023/12/20 J.X.
Signature	Date	
Check By	2	2024/01/17 J.X.
Donny Di V	3	
Signature	Date	
Checked & Approved By Designer	4	
Jaclyn Van M	5	1:40
Signature	Date	Scale:

I have read and fully understand this Autocad drawing. The design, finishes, colour and dimensions are correct. I understand that this signed Autocad drawing will supersede any verbal or other written agreements. I understand once this drawing is signed and sent to production, no more changes may be made.

<b>Approval :</b>	Page 2 of 47
<b>Date :</b>	Kitchen

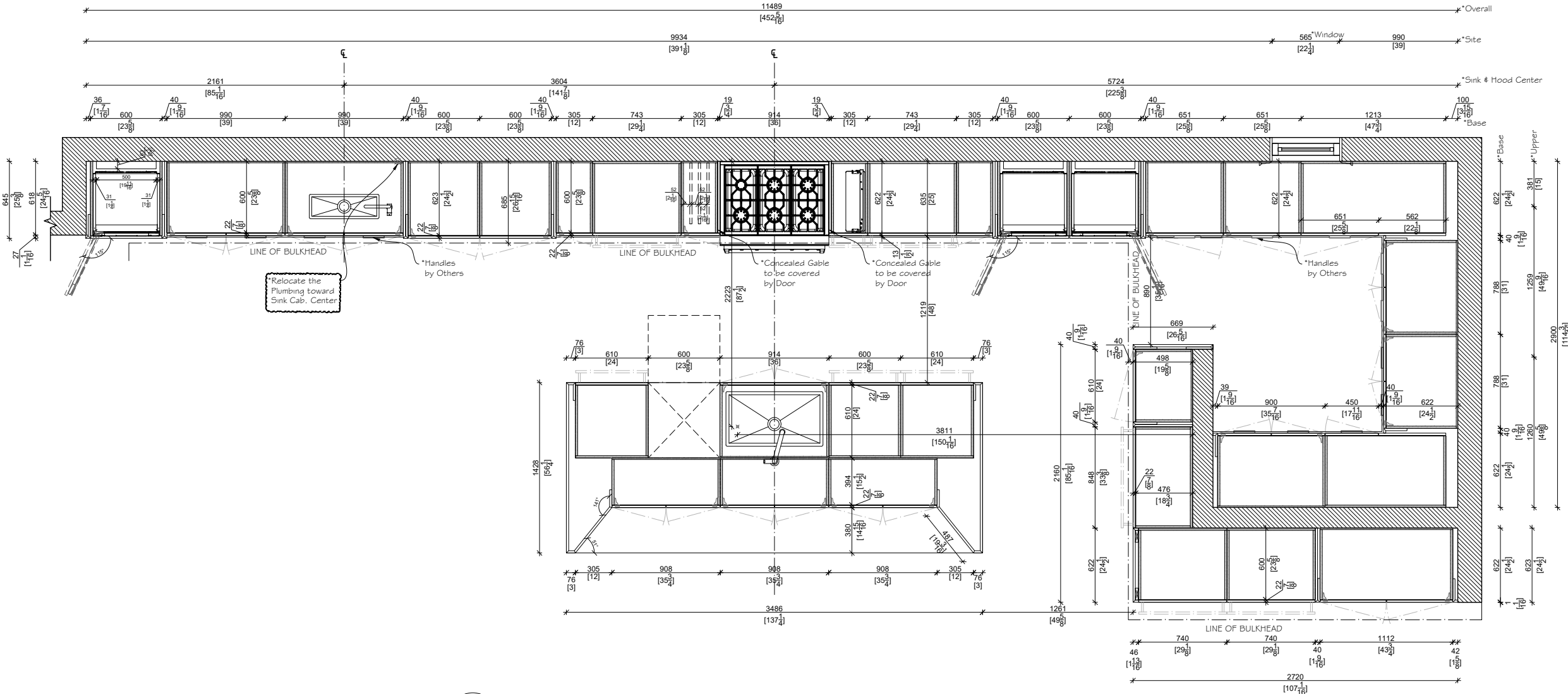

PLAN - BASE LAYOUT  
SCALE: 1:40

\* Existing Hot & Cold Water Pipes  
\* Existing Drainage

**NOTE:**

Copyright © 2022 Pure Kitchens. All rights reserved.

<b>Job #</b>	PK24-001
<b>Client :</b>	Anthony Macri-Sixth Avenue Homes
<b>Address :</b>	35 Botfield Ave, Etobicoke, ON M9B 4E2
<b>Tel :</b>	416-278-9937
<b>Email :</b>	-
<b>Date :</b>	Oct. 30, 2023

**TOP ALIGNMENT**

<b>Bulkhead Height(B.H.)</b>	274.6 cm		
<b>Cabinet Mounting Height</b>	266.0 cm		
<b>Project</b>	Stove Wall Base & Island & Shelf & Entry Closet	Kitchen Pantry & Base Cab.	Hood & Stove Wall Panel
<b>Const.</b>	Frameless	Frameless	Frameless
<b>Door</b>	Slab	Slab	-
<b>Species</b>	AGT PET	Egger TFL	Egger TFL
<b>Grain Dir.</b>	N/A	As per drawing	-
<b>Finish</b>	Prefinished	Prefinished	Prefinished
<b>Colour</b>	Black 723 Soft Touch	H3152 ST19 Bleached Vicenza Oak	F629 ST16 Black Gold Metal Slate
<b>Interior</b>	3/4" Tafisa L203 Black TFL		
<b>End Panel</b>	Flat		
<b>Edge Tape</b>	match Exterior		
<b>Drw.&amp;Slide</b>	Grass Vionaro (Graphite) & Dynapro		
<b>Toe Kick</b>	TYP.		
<b>Handles</b>	Gola C Shape Profile & Gola L Shape Profile (Matte Black)		

**CROWN & TRIMS**

<b>CM #</b>	Flush Fascia
<b>Bead</b>	-
<b>Baseboard #</b>	-
<b>Light Valance</b>	-

**GLASS/MIRROR & METAL**

<b>Mirror</b>	Textured (Code: -)
<b>Aluminum Frame</b>	-
<b>Metal Cladding</b>	-
<b>Light Extrusion</b>	JOYO Light LS1613 by PK

Drawn & Reviewed By	#	Revision Date
Jack X	1	2023/12/20 J.X.
Signature	Date	
Check By	2	2024/01/17 J.X.
Donny Di V	3	
Signature	Date	
Checked & Approved By Designer	4	
Jaclyn Van M	5	1:25
Signature	Date	Scale:

I have read and fully understand this Autocad drawing. The design, finishes, colour and dimensions are correct. I understand that this signed Autocad drawing will supersede any verbal or other written agreements. I understand once this drawing is signed and sent to production, no more changes may be made.

<b>Approval :</b>	Page 3 of 47
<b>Date :</b>	Kitchen

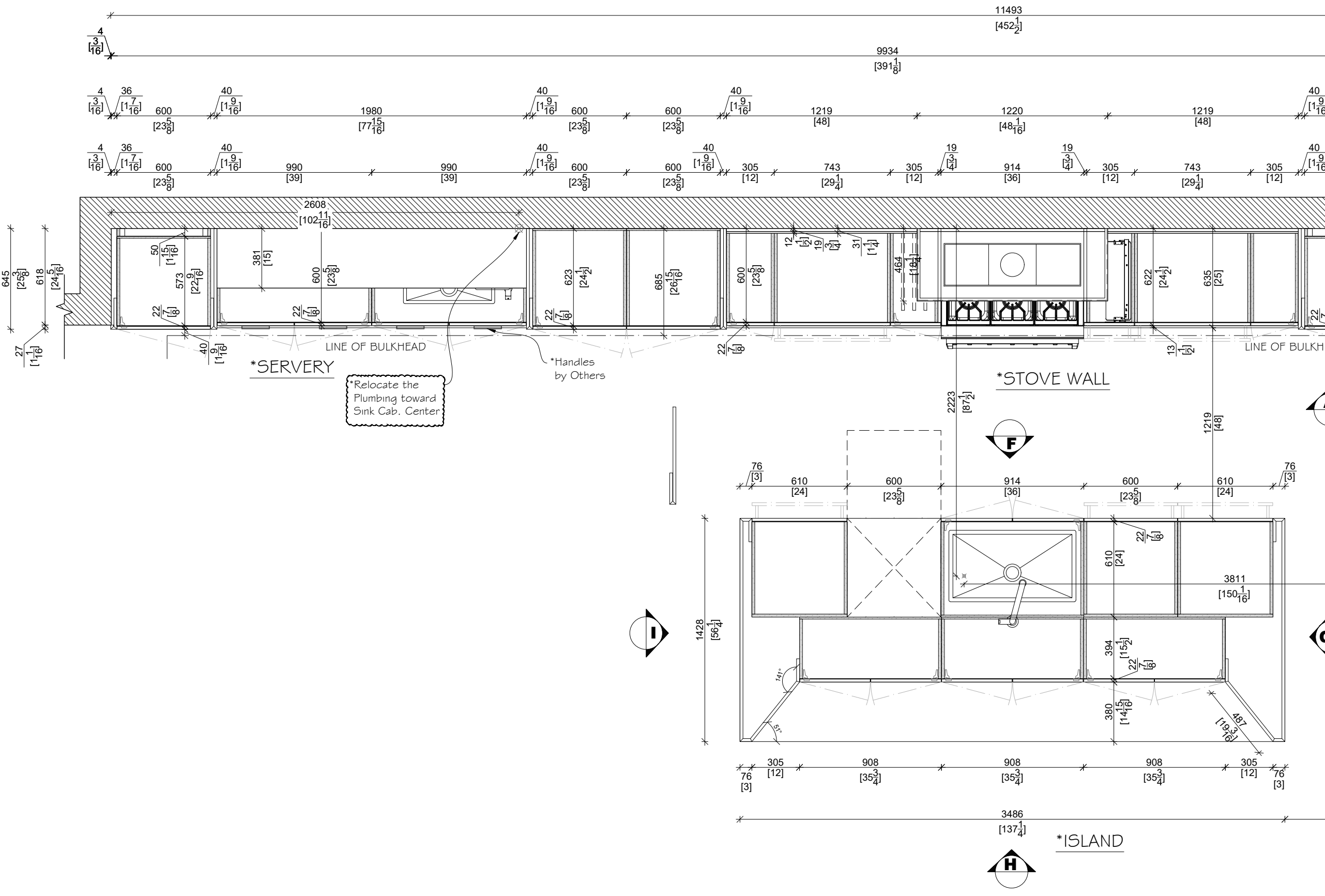

**NOTE:**

Copyright © 2022 Pure Kitchens. All rights reserved.

<b>Job #</b>	PK24-001
<b>Client :</b>	Anthony Macri-Sixth Avenue Homes
<b>Address :</b>	35 Botfield Ave, Etobicoke, ON M9B 4E2
<b>Tel :</b>	416-278-9937
<b>Email :</b>	-
<b>Date :</b>	Oct. 30, 2023

**TOP ALIGNMENT**

<b>Bulkhead Height(B.H.)</b>	274.6 cm
<b>Cabinet Mounting Height</b>	266.0 cm

Project	Stove Wall Base & Island & Shelf & Entry Closet	Kitchen Pantry & Base Cab.	Hood & Stove Wall Panel
<b>Const.</b>	Frameless	Frameless	Frameless
<b>Door</b>	Slab	Slab	-
<b>Species</b>	AGT PET	Egger TFL	Egger TFL
<b>Grain Dir.</b>	N/A	As per drawing	-
<b>Finish</b>	Prefinished	Prefinished	Prefinished
<b>Colour</b>	Black 723 Soft Touch	H3152 ST19 Bleached Vicenza Oak	F629 ST16 Black Gold Metal Slate

<b>Interior</b>	3/4" Tafisa L203 Black TFL
<b>End Panel</b>	Flat
<b>Edge Tape</b>	match Exterior
<b>Drw.&amp;Slide</b>	Grass Vionaro (Graphite) & Dynapro
<b>Toe Kick</b>	TYP.
<b>Handles</b>	Gola C Shape Profile & Gola L Shape Profile (Matte Black)

**CROWN & TRIMS**

<b>CM #</b>	Flush Fascia
<b>Bead</b>	-
<b>Baseboard #</b>	-
<b>Light Valance</b>	-

**GLASS/MIRROR & METAL**

<b>Mirror</b>	Textured (Code: -)
<b>Aluminum Frame</b>	-
<b>Metal Cladding</b>	-
<b>Light Extrusion</b>	JOYO Light LS1613 by PK



Drawn & Reviewed By	#	Revision Date
Jack X	1	2023/12/20 J.X.
Signature	Date	
Check By	2	2024/01/17 J.X.
Donny Di V	3	
Signature	Date	
Checked & Approved By Designer	4	
Jaelyn Van M	5	1:25
Signature	Date	Scale:

I have read and fully understand this Autocad drawing. The design, finishes, colour and dimensions are correct. I understand that this signed Autocad drawing will supersede any verbal or other written agreements. I understand once this drawing is signed and sent to production, no more changes may be made.

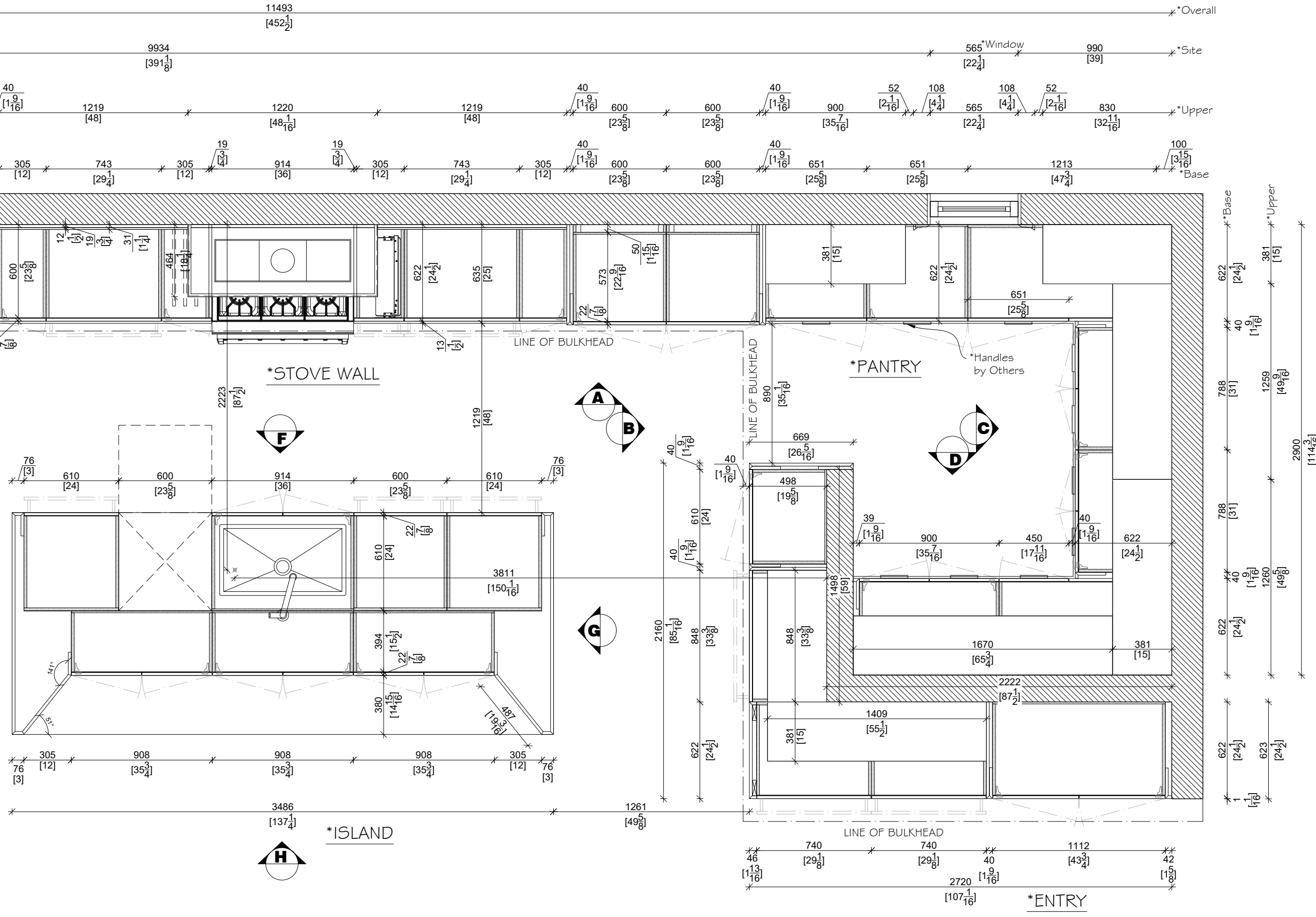
<b>Approval :</b>	Page 4 of 47
<b>Date :</b>	Kitchen



**NOTE:**

	*EGGER TFL *H3152 ST19 BLEACHED VICENZA OAK		*AGT PET *BLACK 723 SOFT TOUCH
	*EGGER TFL *F629 ST16 BLACK GOLD METAL SLATE		

Copyright © 2022 Pure Kitchens. All rights reserved.

<b>Job #</b>	PK24-001
<b>Client :</b>	Anthony Macri-Sixth Avenue Homes
<b>Address :</b>	35 Botfield Ave, Etobicoke, ON M9B 4E2
<b>Tel :</b>	416-278-9937
<b>Email :</b>	-
<b>Date :</b>	Oct. 30, 2023

**TOP ALIGNMENT**

<b>Bulkhead Height(B.H.)</b>	274.6 cm
<b>Cabinet Mounting Height</b>	266.0 cm

Project	Stove Wall Base & Island & Shelf & Entry Closet	Kitchen Pantry & Base Cab.	Hood & Stove Wall Panel
<b>Const.</b>	Frameless	Frameless	Frameless
<b>Door</b>	Slab	Slab	-
<b>Species</b>	AGT PET	Egger TFL	Egger TFL
<b>Grain Dir.</b>	N/A	As per drawing	-
<b>Finish</b>	Prefinished	Prefinished	Prefinished
<b>Colour</b>	Black 723 Soft Touch	H3152 ST19 Bleached Vicenza Oak	F629 ST16 Black Gold Metal Slate

<b>Interior</b>	3/4" Tafisa L203 Black TFL
<b>End Panel</b>	Flat
<b>Edge Tape</b>	match Exterior
<b>Drw.&amp;Slide</b>	Grass Vionario (Graphite) & Dynapro
<b>Toe Kick</b>	TYP.
<b>Handles</b>	Gola C Shape Profile & Gola L Shape Profile (Matte Black)

**CROWN & TRIMS**

<b>CM #</b>	Flush Fascia
<b>Bead</b>	-
<b>Baseboard #</b>	-
<b>Light Valance</b>	-

**GLASS/MIRROR & METAL**

<b>Mirror</b>	Textured (Code: -)
<b>Aluminum Frame</b>	-
<b>Metal Cladding</b>	-
<b>Light Extrusion</b>	JOYO Light LS1613 by PK

Drawn & Reviewed By	#	Revision Date
Jack X	1	2023/12/20 J.X.
Signature	Date	
Check By	2	2024/01/17 J.X.
Donny Di V	3	
Signature	Date	
Checked & Approved By Designer	4	
Jaclyn Van M	5	1:38
Signature	Date	Scale:

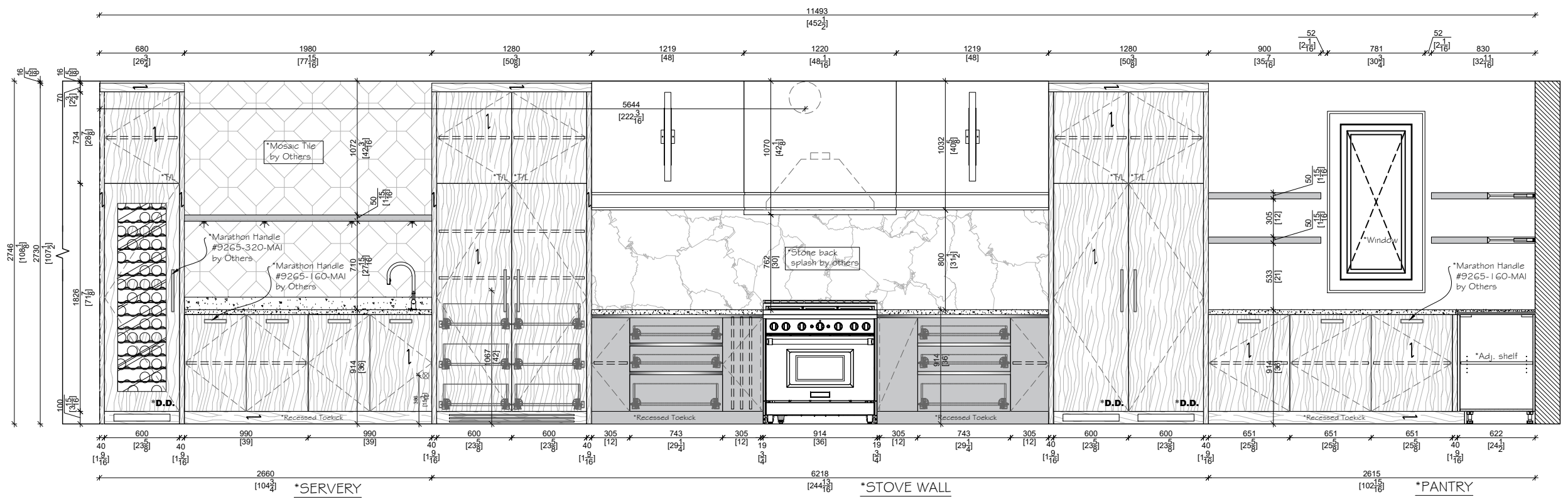

I have read and fully understand this Autocad drawing. The design, finishes, colour and dimensions are correct. I understand that this signed Autocad drawing will supersede any verbal or other written agreements. I understand once this drawing is signed and sent to production, no more changes may be made.

<b>Approval :</b>	Page 5 of 47
<b>Date :</b>	Kitchen



**ELEVATION A**  
 SCALE: 1:25

**NOTE:**

	*EGGER TFL *H3152 ST19 BLEACHED VICENZA OAK		*AGT PET *BLACK 723 SOFT TOUCH
	*EGGER TFL *F629 ST16 BLACK GOLD METAL SLATE		

Copyright © 2022 Pure Kitchens. All rights reserved.

<b>Job #</b>	PK24-001
<b>Client :</b>	Anthony Macri-Sixth Avenue Homes
<b>Address :</b>	35 Botfield Ave, Etobicoke, ON M9B 4E2
<b>Tel :</b>	416-278-9937
<b>Email :</b>	-
<b>Date :</b>	Oct. 30, 2023

**TOP ALIGNMENT**

<b>Bulkhead Height(B.H.)</b>	274.6 cm
<b>Cabinet Mounting Height</b>	266.0 cm

Project	Stove Wall Base & Island & Shelf & Entry Closet	Kitchen Pantry & Base Cab.	Hood & Stove Wall Panel
<b>Const.</b>	Frameless	Frameless	Frameless
<b>Door</b>	Slab	Slab	-
<b>Species</b>	AGT PET	Egger TFL	Egger TFL
<b>Grain Dir.</b>	N/A	As per drawing	-
<b>Finish</b>	Prefinished	Prefinished	Prefinished
<b>Colour</b>	Black 723 Soft Touch	H3152 ST19 Bleached Vicenza Oak	F629 ST16 Black Gold Metal Slate

<b>Interior</b>	3/4" Tafisa L203 Black TFL
<b>End Panel</b>	Flat
<b>Edge Tape</b>	match Exterior
<b>Drw.&amp;Slide</b>	Grass Vionaro (Graphite) & Dynapro
<b>Toe Kick</b>	TYP.
<b>Handles</b>	Gola C Shape Profile & Gola L Shape Profile (Matte Black)

**CROWN & TRIMS**

<b>CM #</b>	Flush Fascia
<b>Bead</b>	-
<b>Baseboard #</b>	-
<b>Light Valance</b>	-

**GLASS/MIRROR & METAL**

<b>Mirror</b>	Textured (Code: -)
<b>Aluminum Frame</b>	-
<b>Metal Cladding</b>	-
<b>Light Extrusion</b>	JOYO Light LS1613 by PK

Drawn & Reviewed By	#	Revision Date
Jack X	1	2023/12/20 J.X.
Signature	Date	
Donny Di V	2	2024/01/17 J.X.
Signature	Date	
Checked & Approved By Designer	3	
Jaelyn Van M	4	
Signature	Date	
	5	1:25
		<b>Scale:</b>

I have read and fully understand this Autocad drawing. The design, finishes, colour and dimensions are correct. I understand that this signed Autocad drawing will supersede any verbal or other written agreements. I understand once this drawing is signed and sent to production, no more changes may be made.

<b>Approval :</b>	Page 6 of 47
<b>Date :</b>	Kitchen

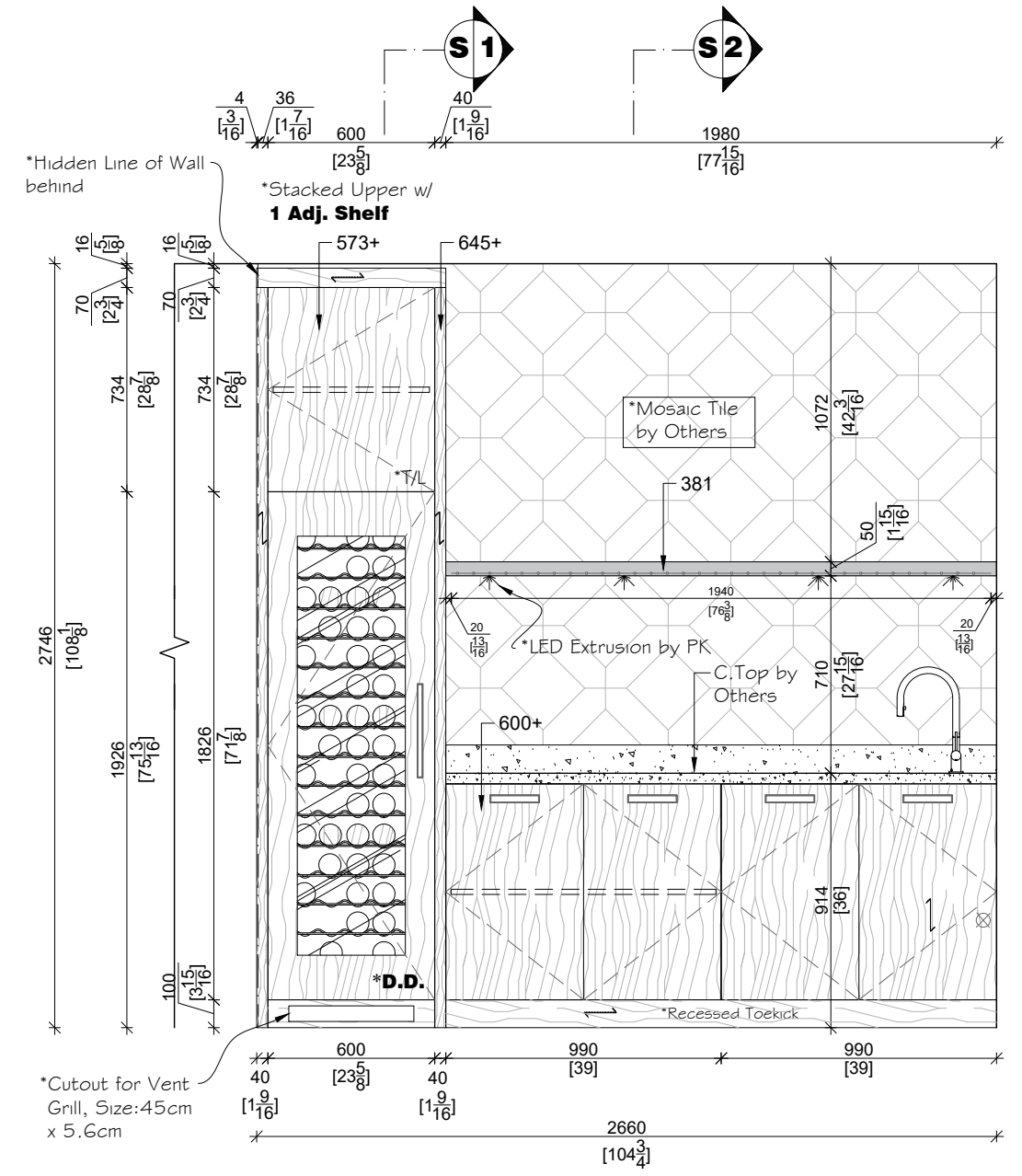

- \*Liebherr Built-in Wine Fridge #HW8000
- \*Base Cab. w/ 1 Adj. Shelf
- \*Sink Base Cab. \*TECO #130(23"x8")
- \*Flush Installation
- \*D.D. Panel

**\*SERVERY ELEVATION**

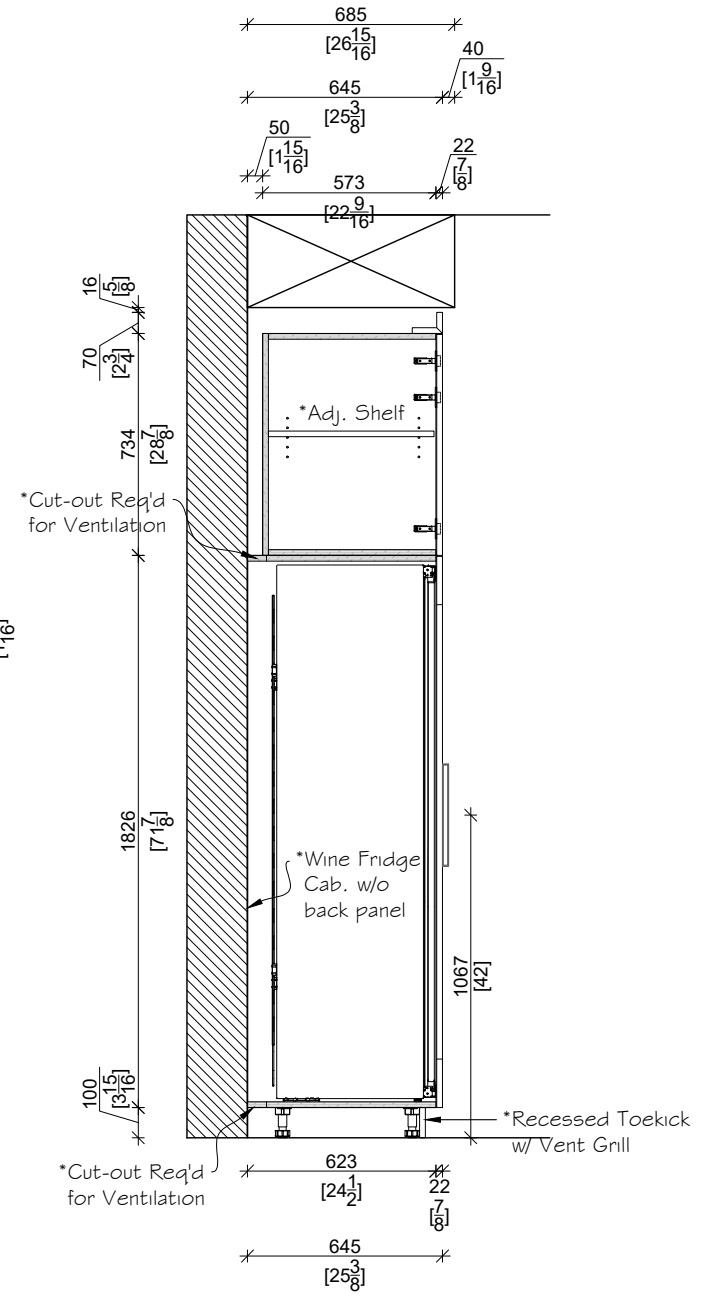

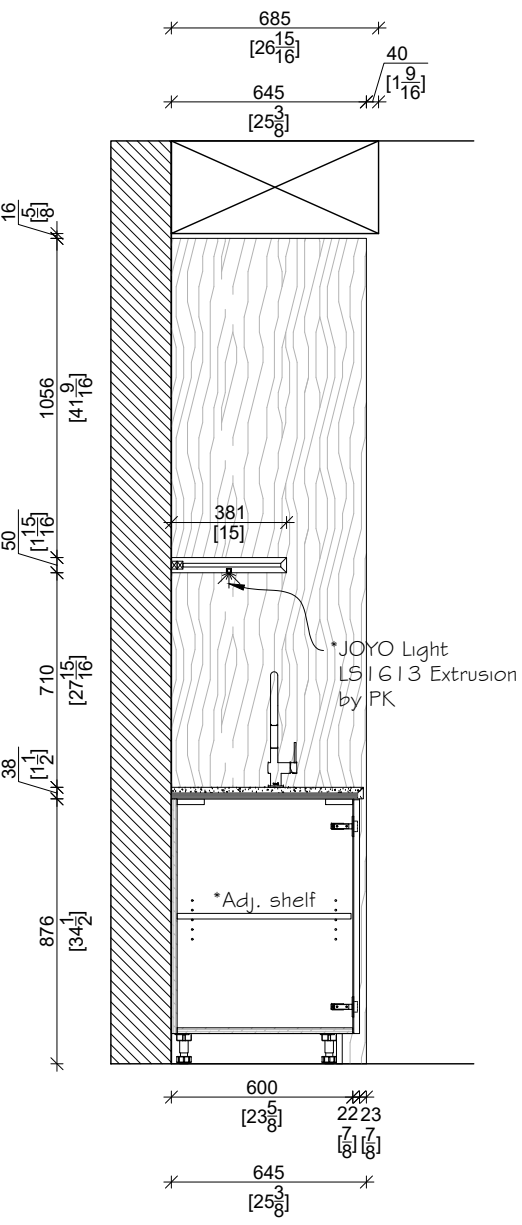

**S1-SECTION**  
SCALE: 1:25



**S2-SECTION**  
SCALE: 1:25

**NOTE:**

	*EGGER TFL *H3152 ST19 BLEACHED VICENZA OAK		*AGT PET *BLACK 723 SOFT TOUCH
	*EGGER TFL *F629 ST16 BLACK GOLD METAL SLATE		

Copyright © 2022 Pure Kitchens. All rights reserved.

<b>Job #</b>	PK24-001
<b>Client :</b>	Anthony Macri-Sixth Avenue Homes
<b>Address :</b>	35 Botfield Ave, Etobicoke, ON M9B 4E2
<b>Tel :</b>	416-278-9937
<b>Email :</b>	-
<b>Date :</b>	Oct. 30, 2023

**TOP ALIGNMENT**

<b>Bulkhead Height(B.H.)</b>	274.6 cm
<b>Cabinet Mounting Height</b>	266.0 cm

Project	Stove Wall Base & Island & Shelf & Entry Closet	Kitchen Pantry & Base Cab.	Hood & Stove Wall Panel
<b>Const.</b>	Frameless	Frameless	Frameless
<b>Door</b>	Slab	Slab	-
<b>Species</b>	AGT PET	Egger TFL	Egger TFL
<b>Grain Dir.</b>	N/A	As per drawing	-
<b>Finish</b>	Prefinished	Prefinished	Prefinished
<b>Colour</b>	Black 723 Soft Touch	H3152 ST19 Bleached Vicenza Oak	F629 ST16 Black Gold Metal Slate
<b>Interior</b>	3/4" Tafisa L203 Black TFL		
<b>End Panel</b>	Flat		
<b>Edge Tape</b>	match Exterior		
<b>Drw.&amp;Slide</b>	Grass Vionario (Graphite) & Dynapro		
<b>Toe Kick</b>	TYP.		
<b>Handles</b>	Gola C Shape Profile & Gola L Shape Profile (Matte Black)		

**CROWN & TRIMS**

<b>CM #</b>	Flush Fascia
<b>Bead</b>	-
<b>Baseboard #</b>	-
<b>Light Valance</b>	-

**GLASS/MIRROR & METAL**

<b>Mirror</b>	Textured (Code: -)
<b>Aluminum Frame</b>	-
<b>Metal Cladding</b>	-
<b>Light Extrusion</b>	JOYO Light LS1613 by PK

Drawn & Reviewed By	#	Revision Date
Jack X	1	2023/12/20 J.X.
Signature	Date	
Donny Di V	2	2024/01/17 J.X.
Signature	Date	
Checked & Approved By Designer	3	
Jaclyn Van M	4	
Signature	Date	
	5	1:25
		Scale:

I have read and fully understand this Autocad drawing. The design, finishes, colour and dimensions are correct. I understand that this signed Autocad drawing will supersede any verbal or other written agreements. I understand once this drawing is signed and sent to production, no more changes may be made.

<b>Approval :</b>	Page 7 of 47
<b>Date :</b>	Kitchen

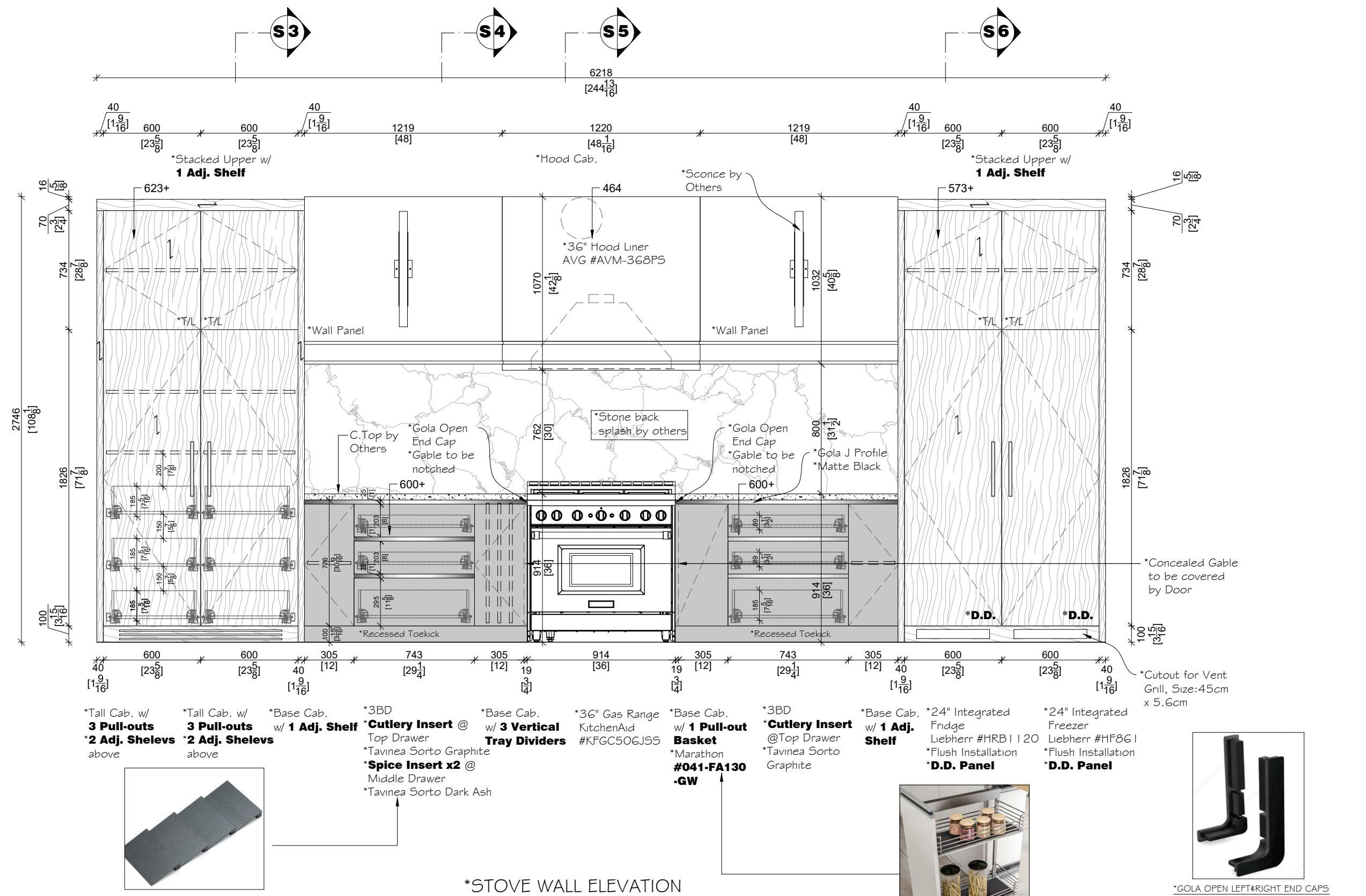

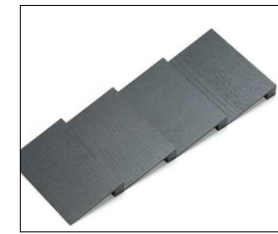

- \*Tall Cab. w/ 3 Pull-outs
- \*Tall Cab. w/ 3 Pull-outs
- \*Base Cab. w/ 1 Adj. Shelf
- \*3BD Cutlery Insert @ Top Drawer
- \*Base Cab. w/ 3 Vertical Tray Dividers
- \*36" Gas Range KitchenAid #KFGC50GJSS
- \*Base Cab. w/ 1 Pull-out Basket
- \*3BD Cutlery Insert @ Top Drawer
- \*Base Cab. w/ 1 Adj. Shelf
- \*24" Integrated Fridge Liebherr #HRB1120
- \*24" Integrated Freezer Liebherr #HF861
- \*2 Adj. Shelves above
- \*2 Adj. Shelves above
- \*Base Cab. w/ 1 Adj. Shelf
- \*Spice Insert x2 @ Middle Drawer
- \*Tavinea Sorto Graphite
- \*Tavinea Sorto Dark Ash
- \*Marathon #041-FA130-GW
- \*Tavinea Sorto Graphite
- \*Flush Installation
- \*Flush Installation



\*GOLA OPEN LEFT&RIGHT END CAPS  
\*MATTE BLACK

**NOTE:**

	*EGGER TFL *H3152 ST19 BLEACHED VICENZA OAK		*AGT PET *BLACK 723 SOFT TOUCH
	*EGGER TFL *F629 ST16 BLACK GOLD METAL SLATE		

Copyright © 2022 Pure Kitchens. All rights reserved.

<b>Job #</b>	PK24-001
<b>Client :</b>	Anthony Macri-Sixth Avenue Homes
<b>Address :</b>	35 Botfield Ave, Etobicoke, ON M9B 4E2
<b>Tel :</b>	416-278-9937
<b>Email :</b>	-
<b>Date :</b>	Oct. 30, 2023

**TOP ALIGNMENT**

<b>Bulkhead Height(B.H.)</b>	274.6 cm
<b>Cabinet Mounting Height</b>	266.0 cm

Project	Stove Wall Base & Island & Shelf & Entry Closet	Kitchen Pantry & Base Cab.	Hood & Stove Wall Panel
<b>Const.</b>	Frameless	Frameless	Frameless
<b>Door</b>	Slab	Slab	-
<b>Species</b>	AGT PET	Egger TFL	Egger TFL
<b>Grain Dir.</b>	N/A	As per drawing	-
<b>Finish</b>	Prefinished	Prefinished	Prefinished
<b>Colour</b>	Black 723 Soft Touch	H3152 ST19 Bleached Vicenza Oak	F629 ST16 Black Gold Metal Slate
<b>Interior</b>	3/4" Tafisa L203 Black TFL		
<b>End Panel</b>	Flat		
<b>Edge Tape</b>	match Exterior		
<b>Drw.&amp;Slide</b>	Grass Vionaro (Graphite) & Dynapro		
<b>Toe Kick</b>	TYP.		
<b>Handles</b>	Gola C Shape Profile & Gola L Shape Profile (Matte Black)		

**CROWN & TRIMS**

<b>CM #</b>	Flush Fascia
<b>Bead</b>	-
<b>Baseboard #</b>	-
<b>Light Valance</b>	-

**GLASS/MIRROR & METAL**

<b>Mirror</b>	Textured (Code: -)
<b>Aluminum Frame</b>	-
<b>Metal Cladding</b>	-
<b>Light Extrusion</b>	JOYO Light LS1613 by PK

Drawn & Reviewed By	#	Revision Date
Jack X	1	2023/12/20 J.X.
Signature	2	2024/01/17 J.X.
Check By	3	
Donny Di V	4	
Signature	5	1:25
Checked & Approved By Designer	Scale:	
Jaelyn Van M		
Signature	Date	

I have read and fully understand this Autocad drawing. The design, finishes, colour and dimensions are correct. I understand that this signed Autocad drawing will supersede any verbal or other written agreements. I understand once this drawing is signed and sent to production, no more changes may be made.

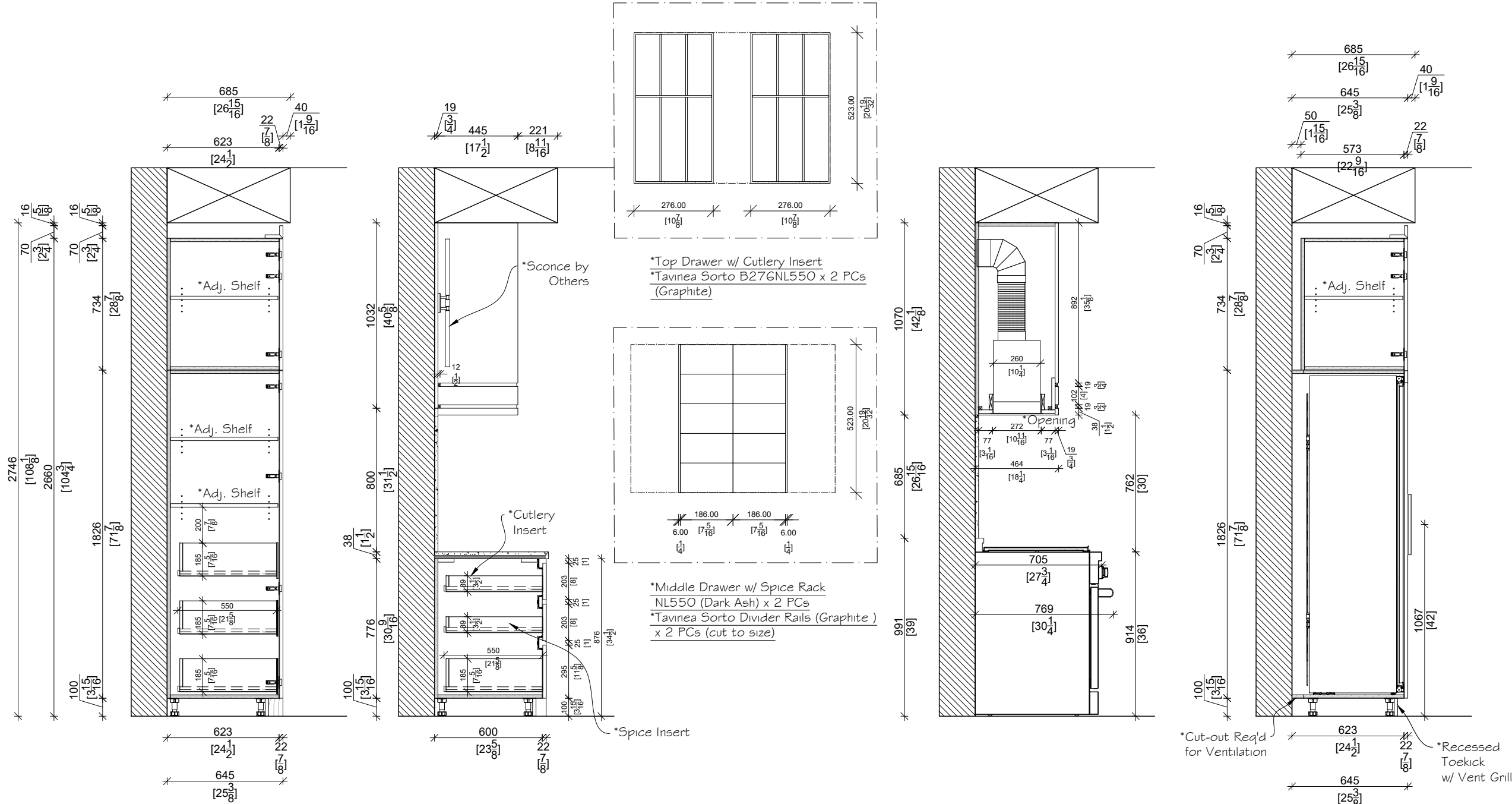

<b>Approval :</b>	Page 8 of 47
<b>Date :</b>	Kitchen



**S5-SECTION**  
SCALE: 1:25



**NOTE:**

	*EGGER TFL *H3152 ST19 BLEACHED VICENZA OAK		*AGT PET *BLACK 723 SOFT TOUCH
	*EGGER TFL *F629 ST16 BLACK GOLD METAL SLATE		

Copyright © 2022 Pure Kitchens. All rights reserved.

<b>Job #</b>	PK24-001
<b>Client :</b>	Anthony Macri-Sixth Avenue Homes
<b>Address :</b>	35 Botfield Ave, Etobicoke, ON M9B 4E2
<b>Tel :</b>	416-278-9937
<b>Email :</b>	-
<b>Date :</b>	Oct. 30, 2023

**TOP ALIGNMENT**

<b>Bulkhead Height(B.H.)</b>	274.6 cm
<b>Cabinet Mounting Height</b>	266.0 cm

Project	Stove Wall Base & Island & Shelf & Entry Closet	Kitchen Pantry & Base Cab.	Hood & Stove Wall Panel
<b>Const.</b>	Frameless	Frameless	Frameless
<b>Door</b>	Slab	Slab	-
<b>Species</b>	AGT PET	Egger TFL	Egger TFL
<b>Grain Dir.</b>	N/A	As per drawing	-
<b>Finish</b>	Prefinished	Prefinished	Prefinished
<b>Colour</b>	Black 723 Soft Touch	H3152 ST19 Bleached Vicenza Oak	F629 ST16 Black Gold Metal Slate

<b>Interior</b>	3/4" Tafisa L203 Black TFL
<b>End Panel</b>	Flat
<b>Edge Tape</b>	match Exterior
<b>Drw.&amp;Slide</b>	Grass Vionario (Graphite) & Dynapro
<b>Toe Kick</b>	TYP.
<b>Handles</b>	Gola C Shape Profile & Gola L Shape Profile (Matte Black)

**CROWN & TRIMS**

<b>CM #</b>	Flush Fascia
<b>Bead</b>	-
<b>Baseboard #</b>	-
<b>Light Valance</b>	-

**GLASS/MIRROR & METAL**

<b>Mirror</b>	Textured (Code: -)
<b>Aluminum Frame</b>	-
<b>Metal Cladding</b>	-
<b>Light Extrusion</b>	JOYO Light LS1613 by PK

Drawn & Reviewed By	#	Revision Date
Jack X	1	2023/12/20 J.X.
Signature	Date	
Donny Di V	2	2024/01/17 J.X.
Signature	Date	
Checked & Approved By Designer	3	
Jaelyn Van M	4	
Signature	Date	
	5	1:25
		Scale:

I have read and fully understand this Autocad drawing. The design, finishes, colour and dimensions are correct. I understand that this signed Autocad drawing will supersede any verbal or other written agreements. I understand once this drawing is signed and sent to production, no more changes may be made.

<b>Approval :</b>	Page 9 of 47
<b>Date :</b>	Kitchen

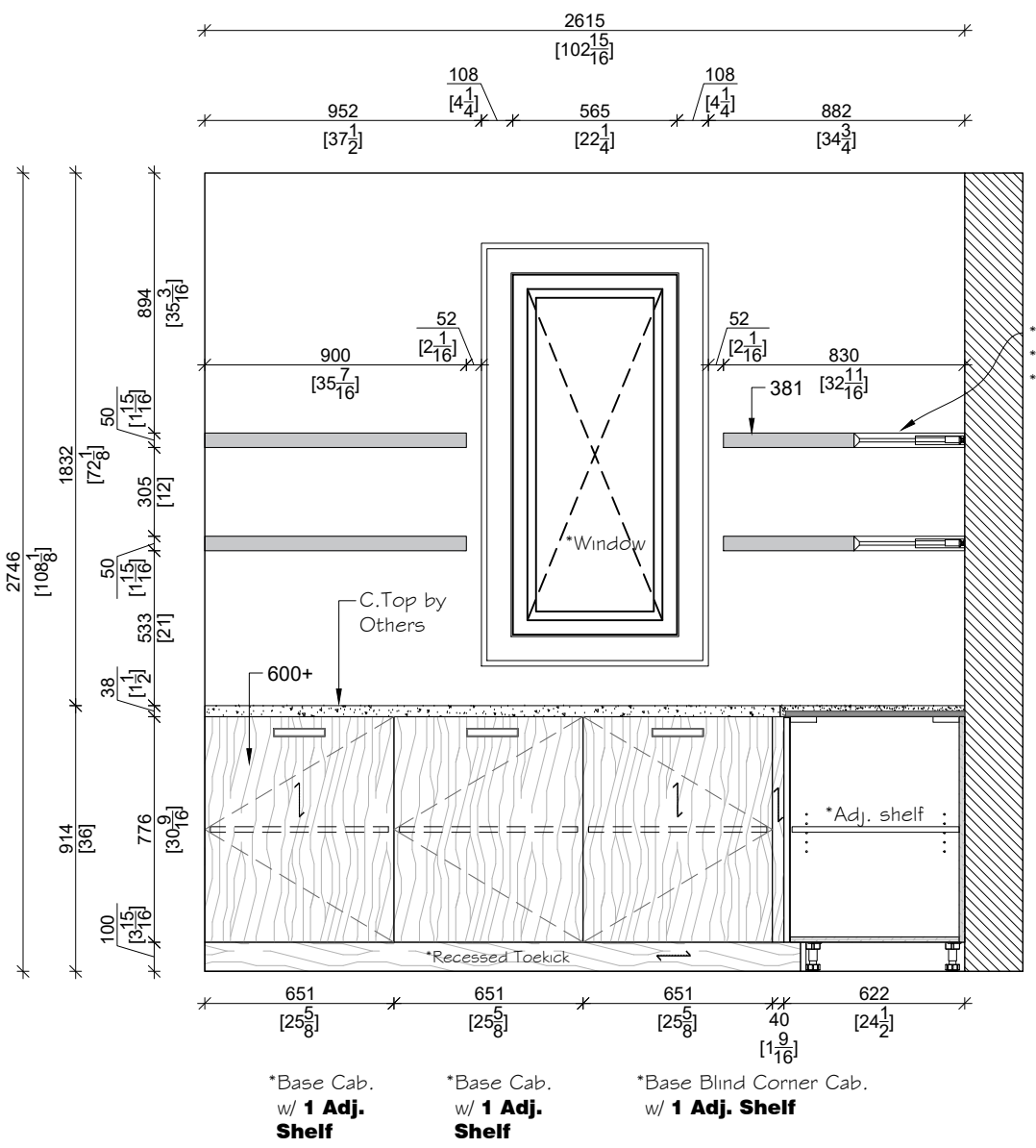

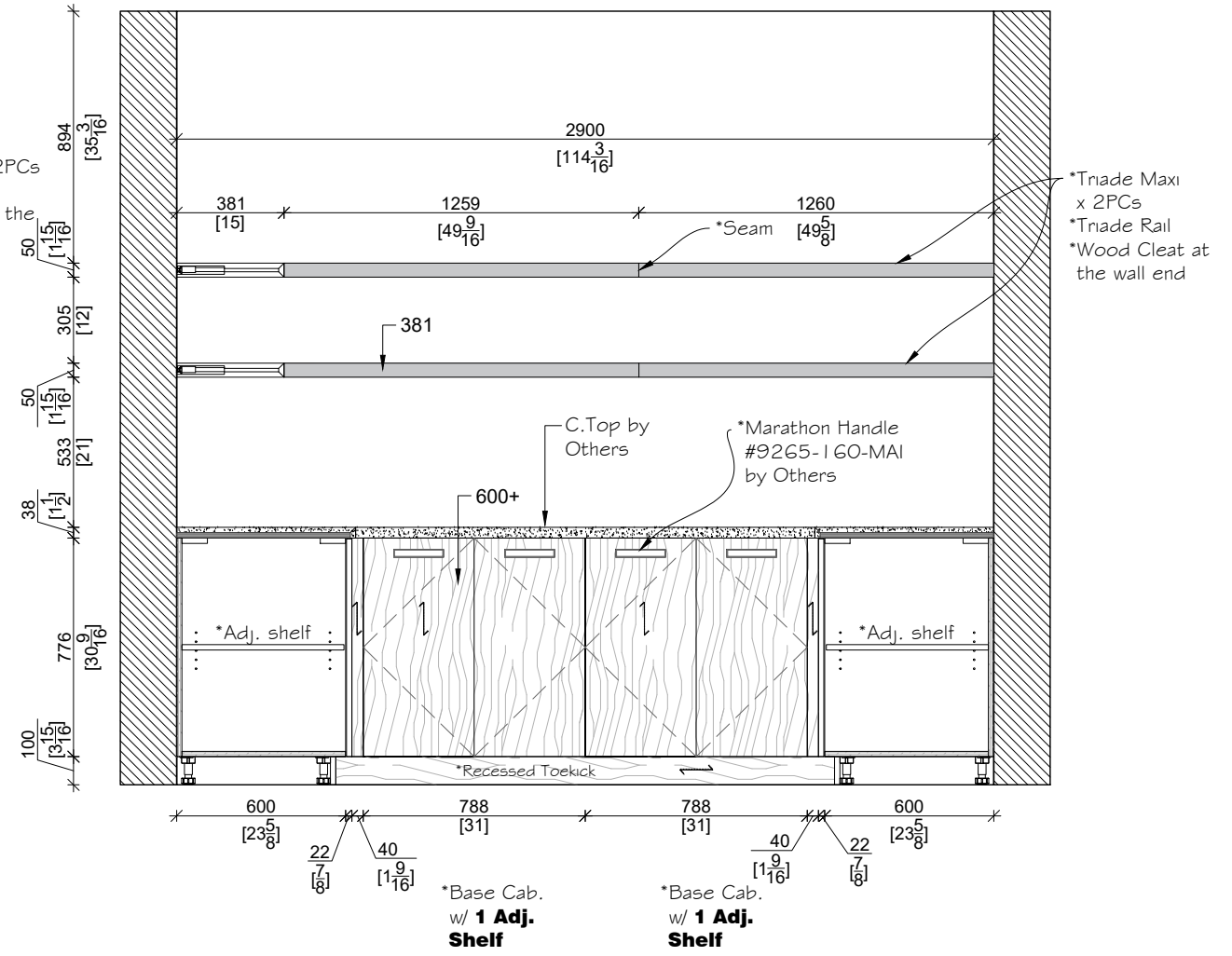

\*PANTRY ELEVATION



**ELEVATION C**  
 SCALE: 1:25

**NOTE:**

	*EGGER TFL *H3152 ST19 BLEACHED VICENZA OAK		*AGT PET *BLACK 723 SOFT TOUCH
	*EGGER TFL *F629 ST16 BLACK GOLD METAL SLATE		

Copyright © 2022 Pure Kitchens. All rights reserved.

<b>Job #</b>	PK24-001
<b>Client :</b>	Anthony Macri-Sixth Avenue Homes
<b>Address :</b>	35 Botfield Ave, Etobicoke, ON M9B 4E2
<b>Tel :</b>	416-278-9937
<b>Email :</b>	-
<b>Date :</b>	Oct. 30, 2023

**TOP ALIGNMENT**

<b>Bulkhead Height(B.H.)</b>	274.6 cm
<b>Cabinet Mounting Height</b>	266.0 cm

Project	Stove Wall Base & Island & Shelf & Entry Closet	Kitchen Pantry & Base Cab.	Hood & Stove Wall Panel
<b>Const.</b>	Frameless	Frameless	Frameless
<b>Door</b>	Slab	Slab	-
<b>Species</b>	AGT PET	Egger TFL	Egger TFL
<b>Grain Dir.</b>	N/A	As per drawing	-
<b>Finish</b>	Prefinished	Prefinished	Prefinished
<b>Colour</b>	Black 723 Soft Touch	H3152 ST19 Bleached Vicenza Oak	F629 ST16 Black Gold Metal Slate
<b>Interior</b>	3/4" Tafisa L203 Black TFL		
<b>End Panel</b>	Flat		
<b>Edge Tape</b>	match Exterior		
<b>Drw.&amp;Slide</b>	Grass Vionario (Graphite) & Dynapro		
<b>Toe Kick</b>	TYP.		
<b>Handles</b>	Gola C Shape Profile & Gola L Shape Profile (Matte Black)		

**CROWN & TRIMS**

<b>CM #</b>	Flush Fascia
<b>Bead</b>	-
<b>Baseboard #</b>	-
<b>Light Valance</b>	-

**GLASS/MIRROR & METAL**

<b>Mirror</b>	Textured (Code: -)
<b>Aluminum Frame</b>	-
<b>Metal Cladding</b>	-
<b>Light Extrusion</b>	JOYO Light LS1613 by PK

Drawn & Reviewed By	#	Revision Date
Jack X	1	2023/12/20 J.X.
Donny Di V	2	2024/01/17 J.X.
	3	
	4	
Checked & Approved By Designer	5	1:25
Jaelyn Van M		
Signature	Date	Scale:

I have read and fully understand this Autocad drawing. The design, finishes, colour and dimensions are correct. I understand that this signed Autocad drawing will supersede any verbal or other written agreements. I understand once this drawing is signed and sent to production, no more changes may be made.

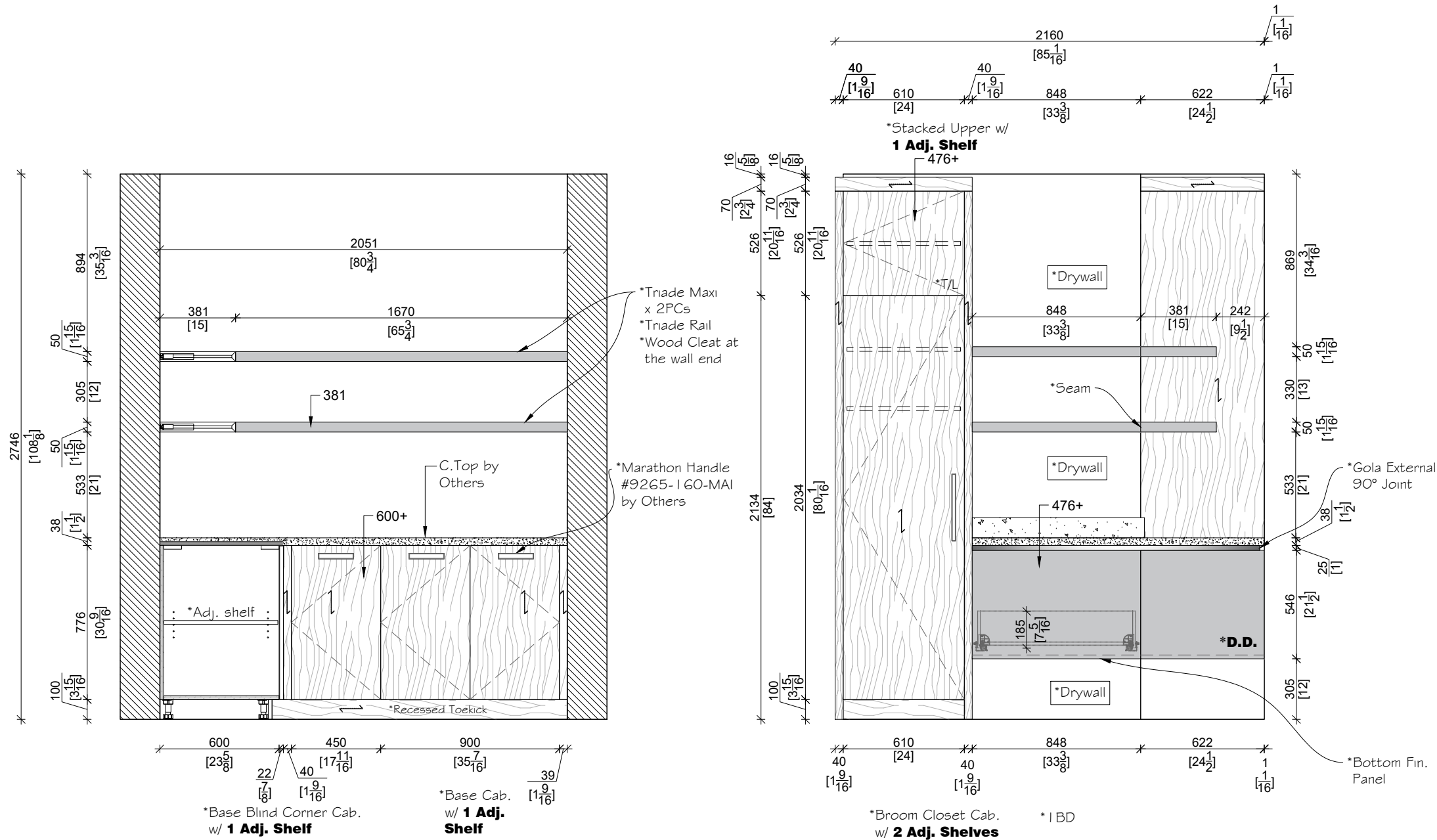

<b>Approval :</b>	Page 10 of 47
<b>Date :</b>	Kitchen



**ELEVATION D**  
SCALE: 1:25

**ELEVATION B**  
SCALE: 1:25

**NOTE:**

	*EGGER TFL *H3152 ST19 BLEACHED VICENZA OAK		*AGT PET *BLACK 723 SOFT TOUCH
	*EGGER TFL *FG29 ST16 BLACK GOLD METAL SLATE		

Copyright © 2022 Pure Kitchens. All rights reserved.

<b>Job #</b>	PK24-001
<b>Client :</b>	Anthony Macri-Sixth Avenue Homes
<b>Address :</b>	35 Botfield Ave, Etobicoke, ON M9B 4E2
<b>Tel :</b>	416-278-9937
<b>Email :</b>	-
<b>Date :</b>	Oct. 30, 2023

**TOP ALIGNMENT**

<b>Bulkhead Height(B.H.)</b>	274.6 cm
<b>Cabinet Mounting Height</b>	266.0 cm

Project	Stove Wall Base & Island & Shelf & Entry Closet	Kitchen Pantry & Base Cab.	Hood & Stove Wall Panel
<b>Const.</b>	Frameless	Frameless	Frameless
<b>Door</b>	Slab	Slab	-
<b>Species</b>	AGT PET	Egger TFL	Egger TFL
<b>Grain Dir.</b>	N/A	As per drawing	-
<b>Finish</b>	Prefinished	Prefinished	Prefinished
<b>Colour</b>	Black 723 Soft Touch	H3152 ST19 Bleached Vicenza Oak	F629 ST16 Black Gold Metal Slate
<b>Interior</b>	3/4" Tafisa L203 Black TFL		
<b>End Panel</b>	Flat		
<b>Edge Tape</b>	match Exterior		
<b>Drw.&amp;Slide</b>	Grass Vionaro (Graphite) & Dynapro		
<b>Toe Kick</b>	TYP.		
<b>Handles</b>	Gola C Shape Profile & Gola L Shape Profile (Matte Black)		

**CROWN & TRIMS**

<b>CM #</b>	Flush Fascia
<b>Bead</b>	-
<b>Baseboard #</b>	-
<b>Light Valance</b>	-

**GLASS/MIRROR & METAL**

<b>Mirror</b>	Textured (Code: -)
<b>Aluminum Frame</b>	-
<b>Metal Cladding</b>	-
<b>Light Extrusion</b>	JOYO Light LS1613 by PK

Drawn & Reviewed By	#	Revision Date
Jack X	1	2023/12/20 J.X.
Signature _____ Date _____	2	2024/01/17 J.X.
Donny Di V	3	
Signature _____ Date _____	4	
Checked & Approved By Designer	5	1:25
Jaclyn Van M		
Signature _____ Date _____		<b>Scale:</b>

I have read and fully understand this Autocad drawing. The design, finishes, colour and dimensions are correct. I understand that this signed Autocad drawing will supersede any verbal or other written agreements. I understand once this drawing is signed and sent to production, no more changes may be made.

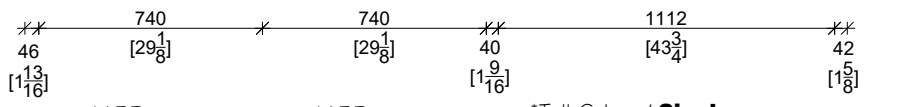
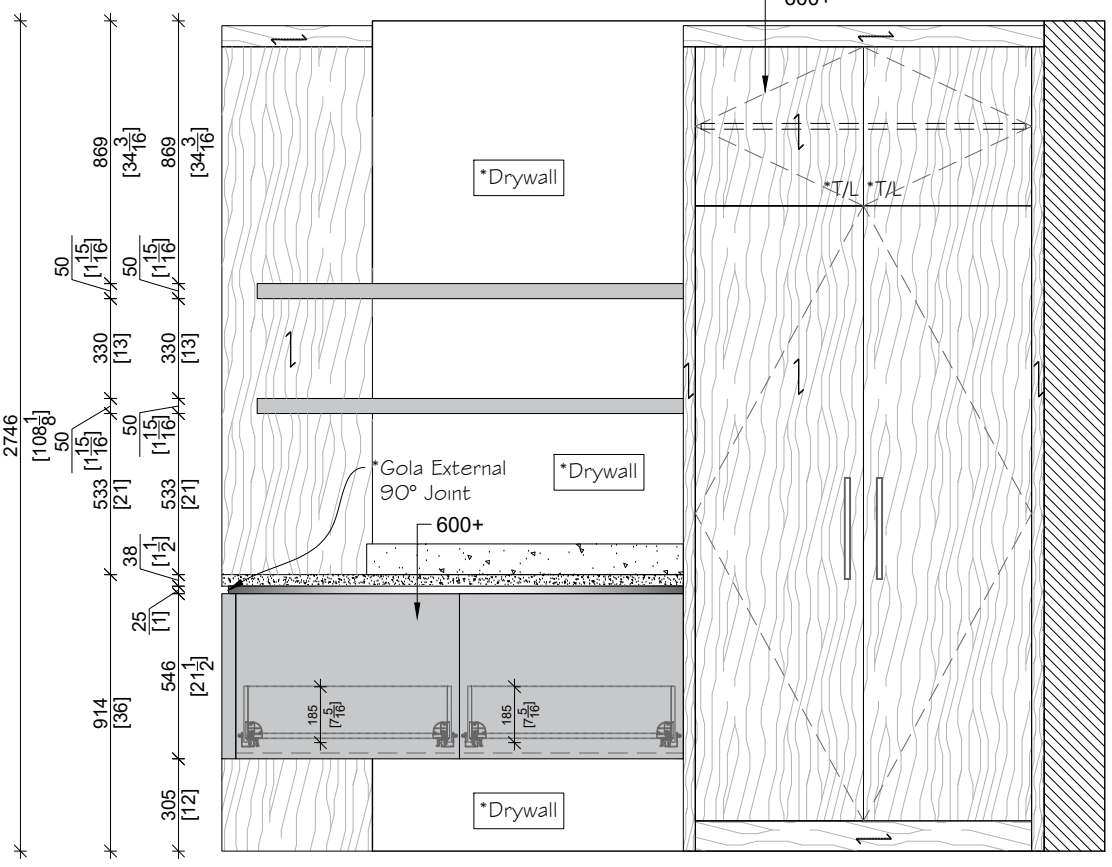
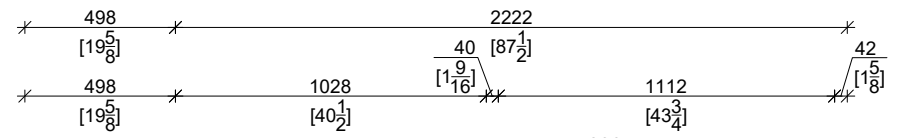

\* IBD      \* IBD      \*Tall Cab. w/ **Single Hanging Rod**  
 \*1 Adj. Shelves below

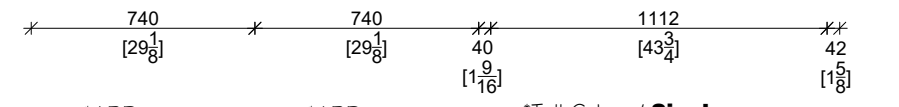
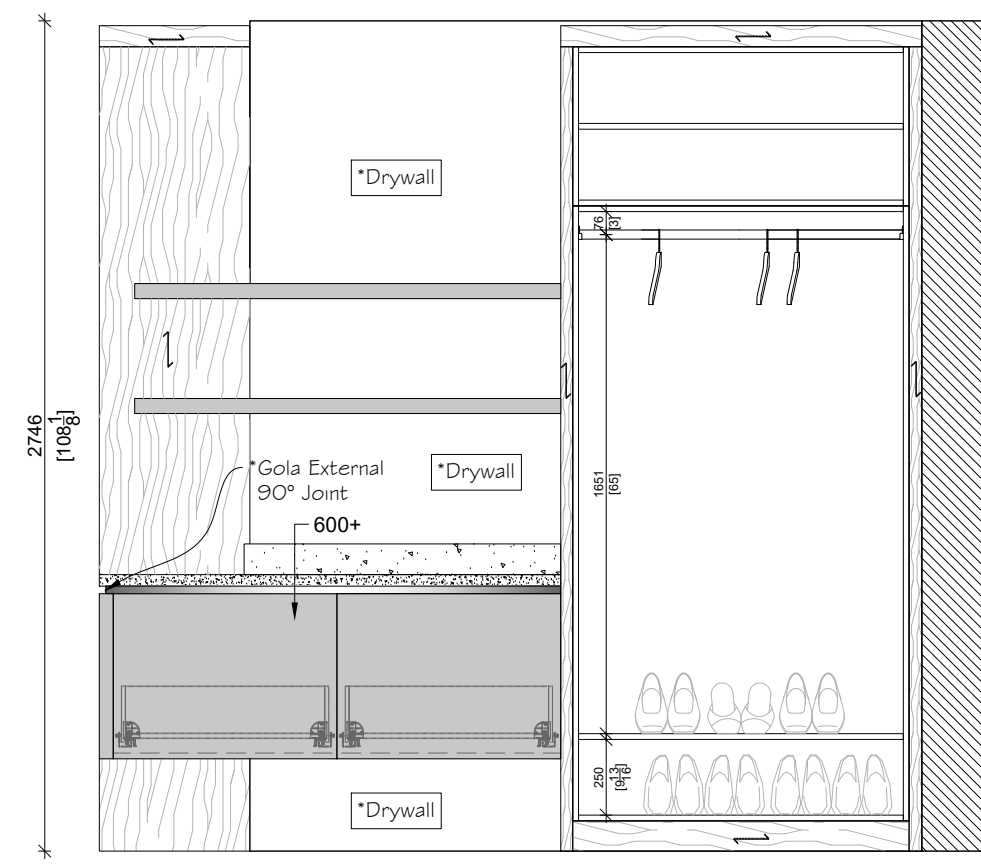

 **ELEVATION E**  
 SCALE: 1:25 (Door Closed)



\* IBD      \* IBD      \*Tall Cab. w/ **Single Hanging Rod**  
 \*1 Adj. Shelves below

 **ELEVATION E**  
 SCALE: 1:25 (Door Opened)

**NOTE:**

-  \*EGGER TFL  
\*H3152 ST19  
BLEACHED VICENZA OAK
-  \*EGGER TFL  
\*F629 ST16  
BLACK GOLD METAL SLATE
-  \*AGT PET  
\*BLACK 723  
SOFT TOUCH



115 Saramia Cres, Unit B  
Vaughan, Ontario  
L4K 4P7  
TEL: (416) 679-0912  
info@purekitchensinc.com

Copyright © 2022 Pure Kitchens. All rights reserved.

<b>Job #</b>	PK24-001
<b>Client :</b>	Anthony Macri-Sixth Avenue Homes
<b>Address :</b>	35 Botfield Ave, Etobicoke, ON M9B 4E2
<b>Tel :</b>	416-278-9937
<b>Email :</b>	-
<b>Date :</b>	Oct. 30, 2023

**TOP ALIGNMENT**

<b>Bulkhead Height(B.H.)</b>	274.6 cm
<b>Cabinet Mounting Height</b>	266.0 cm

Project	Stove Wall Base & Island & Shelf & Entry Closet	Kitchen Pantry & Base Cab.	Hood & Stove Wall Panel
<b>Const.</b>	Frameless	Frameless	Frameless
<b>Door</b>	Slab	Slab	-
<b>Species</b>	AGT PET	Egger TFL	Egger TFL
<b>Grain Dir.</b>	N/A	As per drawing	-
<b>Finish</b>	Prefinished	Prefinished	Prefinished
<b>Colour</b>	Black 723 Soft Touch	H3152 ST19 Bleached Vicenza Oak	F629 ST16 Black Gold Metal Slate
<b>Interior</b>	3/4" Tafisa L203 Black TFL		
<b>End Panel</b>	Flat		
<b>Edge Tape</b>	match Exterior		
<b>Drw.&amp;Slide</b>	Grass Vionaro (Graphite) & Dynapro		
<b>Toe Kick</b>	TYP.		
<b>Handles</b>	Gola C Shape Profile & Gola L Shape Profile (Matte Black)		

**CROWN & TRIMS**

<b>CM #</b>	Flush Fascia
<b>Bead</b>	-
<b>Baseboard #</b>	-
<b>Light Valance</b>	-

**GLASS/MIRROR & METAL**

<b>Mirror</b>	Textured (Code: -)
<b>Aluminum Frame</b>	-
<b>Metal Cladding</b>	-
<b>Light Extrusion</b>	JOYO Light LS1613 by PK

Drawn & Reviewed By	#	Revision Date
Jack X	1	2023/12/20 J.X.
Signature	2	2024/01/17 J.X.
Check By	3	
Donny Di V	4	
Signature	5	1:25
Checked & Approved By Designer	Scale:	
Jaclyn Van M		
Signature	Date	

I have read and fully understand this Autocad drawing. The design, finishes, colour and dimensions are correct. I understand that this signed Autocad drawing will supersede any verbal or other written agreements. I understand once this drawing is signed and sent to production, no more changes may be made.

<b>Approval :</b>	Page 12 of 47
<b>Date :</b>	Kitchen

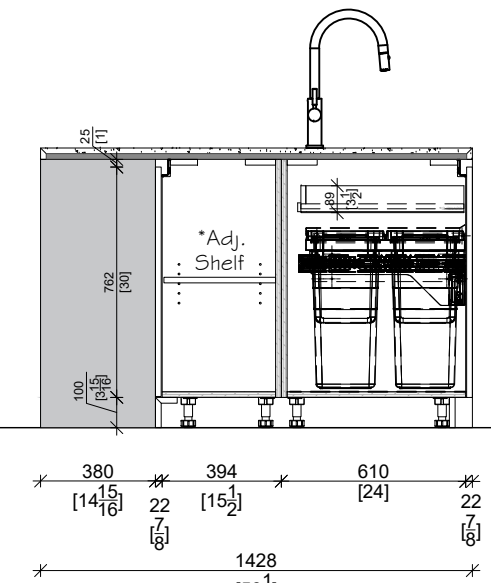
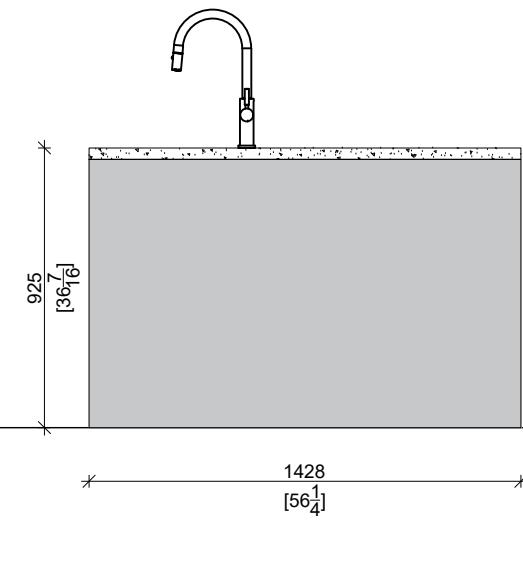
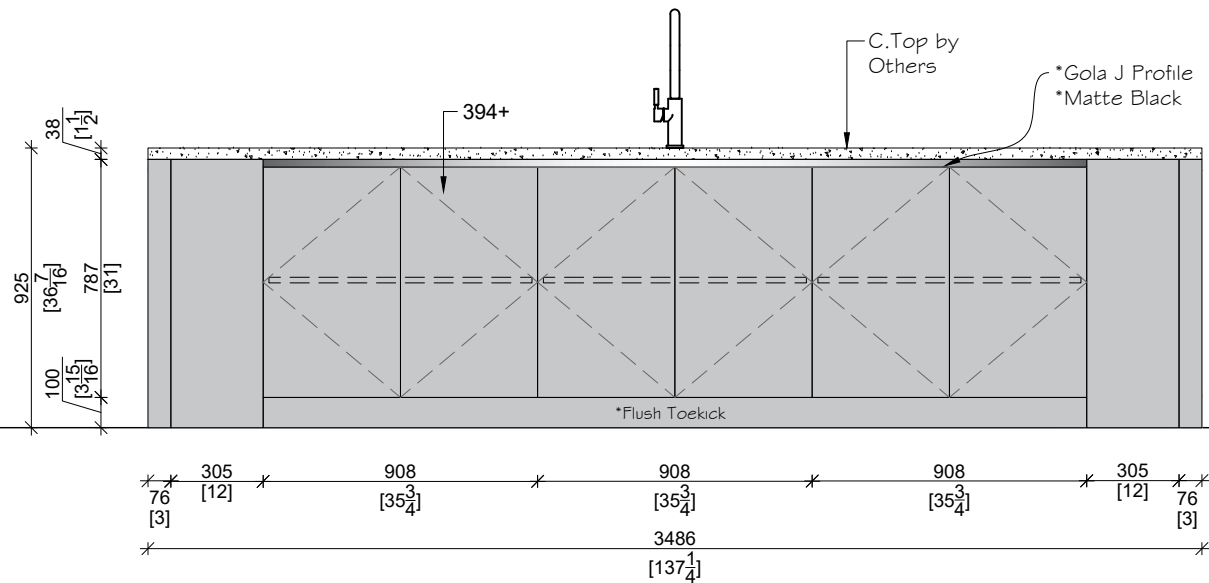

**H - View of Island**  
SCALE: 1:25

**I - View of Island**  
SCALE: 1:25

**S8-SECTION**  
SCALE: 1:25

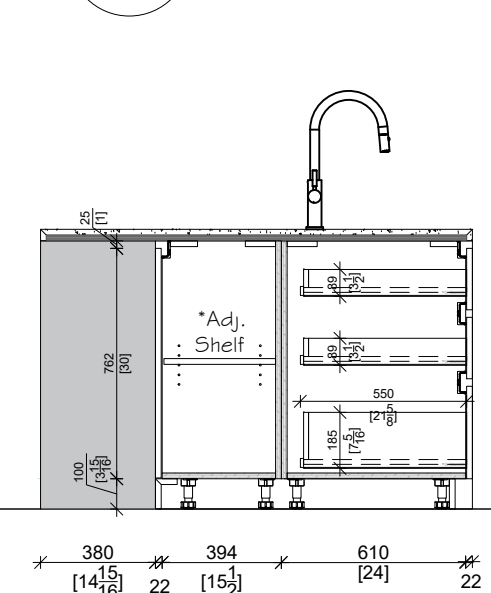
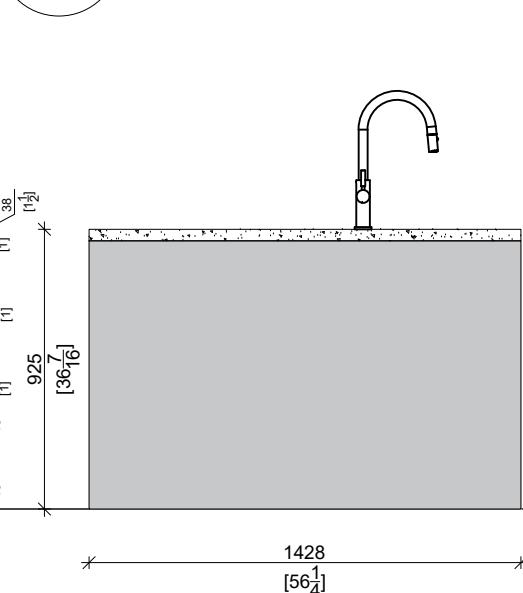
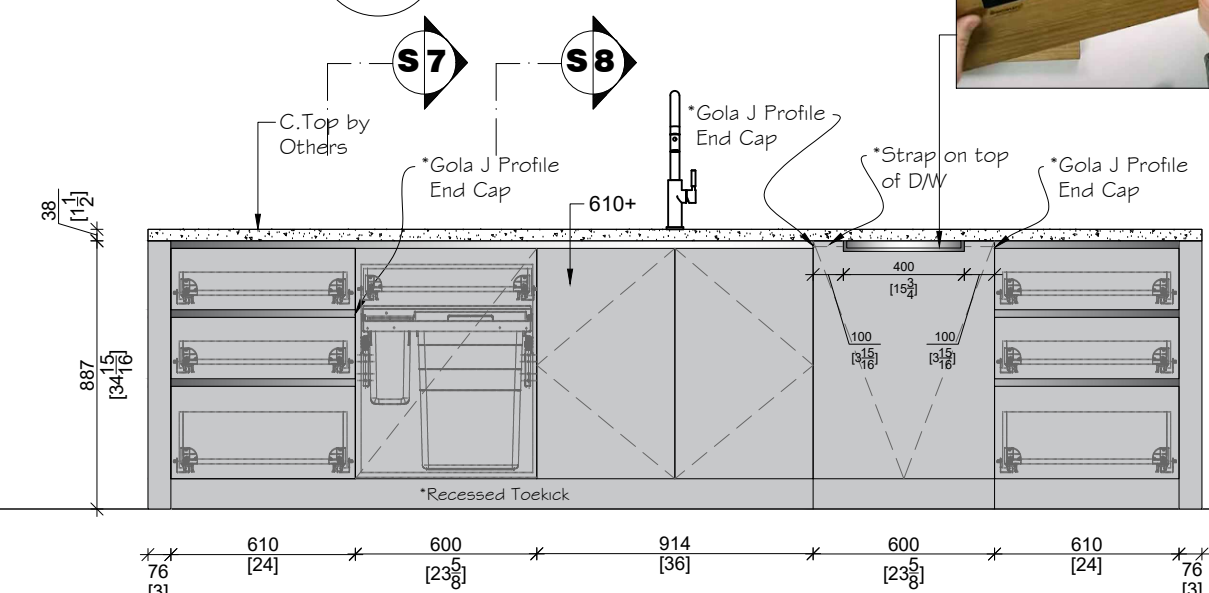

- \*3BD
- \*Base Cab. **\*Euro-Cargo II Recycling Center**
- \*Richelieu **#8461460910**
- \*1 Pull-out Drawer @Top
- \*Sink Base Cab. **\*TECO #140(32"x18")**
- \*24" Dishwasher Bosch **#SHV53CM3N**
- \*D.D. Panel**
- \*Syma32 Intergrated Total (Matte Black)**
- \*3BD

**F - View of Island**  
SCALE: 1:25

**G - View of Island**  
SCALE: 1:25

**S7-SECTION**  
SCALE: 1:25



**NOTE:**

-  \*AGT PET  
\*603HIGH GLOSS METALLIC ELM
-  \*AGT PET  
\*BLACK 723 SOFT TOUCH



115 Saramia Cres, Unit B  
Vaughan, Ontario  
L4K 4P7  
TEL: (416) 679-0912  
info@purekitchensinc.com

Copyright © 2022 Pure Kitchens. All rights reserved.

<b>Job #</b>	PK24-001
<b>Client :</b>	Anthony Macri-Sixth Avenue Homes
<b>Address :</b>	35 Botfield Ave, Etobicoke, ON M9B 4E2
<b>Tel :</b>	416-278-9937
<b>Email :</b>	-
<b>Date :</b>	Oct. 30, 2023

**TOP ALIGNMENT**

<b>Bulkhead Height(B.H.)</b>	275.6 cm	
<b>Cabinet Mounting Height</b>	265.0 cm	
<b>Project</b>	Base & Counter	Upper & Pantry
<b>Const.</b>	Frameless	Frameless
<b>Door</b>	Slab	Slab
<b>Species</b>	AGT PET	AGT PET
<b>Grain Dir.</b>	-	As per drawing
<b>Finish</b>	Prefinished	Prefinished
<b>Colour</b>	Black 723 Soft Touch	603 HG Metallic Elm

<b>Interior</b>	3/4" Tafisa L203 Black TFL	
<b>End Panel</b>	Flat	
<b>Edge Tape</b>	match Exterior	
<b>Drw.&amp;Slide</b>	Grass Vionaro (Graphite) & Dynapro	
<b>Toe Kick</b>	6cm Legs	
<b>Handles</b>	Marathon #8175-CBRZ BY OTHERS Marathon #8175-160-CBRZ BY OTHERS	

**CROWN & TRIMS**

<b>CM #</b>	Flush Fascia
<b>Bead</b>	-
<b>Baseboard #</b>	-
<b>Light Valance</b>	-

**GLASS/MIRROR & METAL**

<b>Mirror</b>	Textured (Code: -)
<b>Aluminum Frame</b>	-
<b>Metal Cladding</b>	-
<b>Light Extrusion</b>	JOYO Light LS1613 by PK

Drawn & Reviewed By	#	Revision Date
Jack X	1	2023/12/20 J.X.
Signature _____ Date _____	2	2024/01/17 J.X.
Check By	3	
Donny Di V	4	
Signature _____ Date _____	5	1:25
Checked & Approved By Designer	Scale:	
Jaelyn Van M		
Signature _____ Date _____		

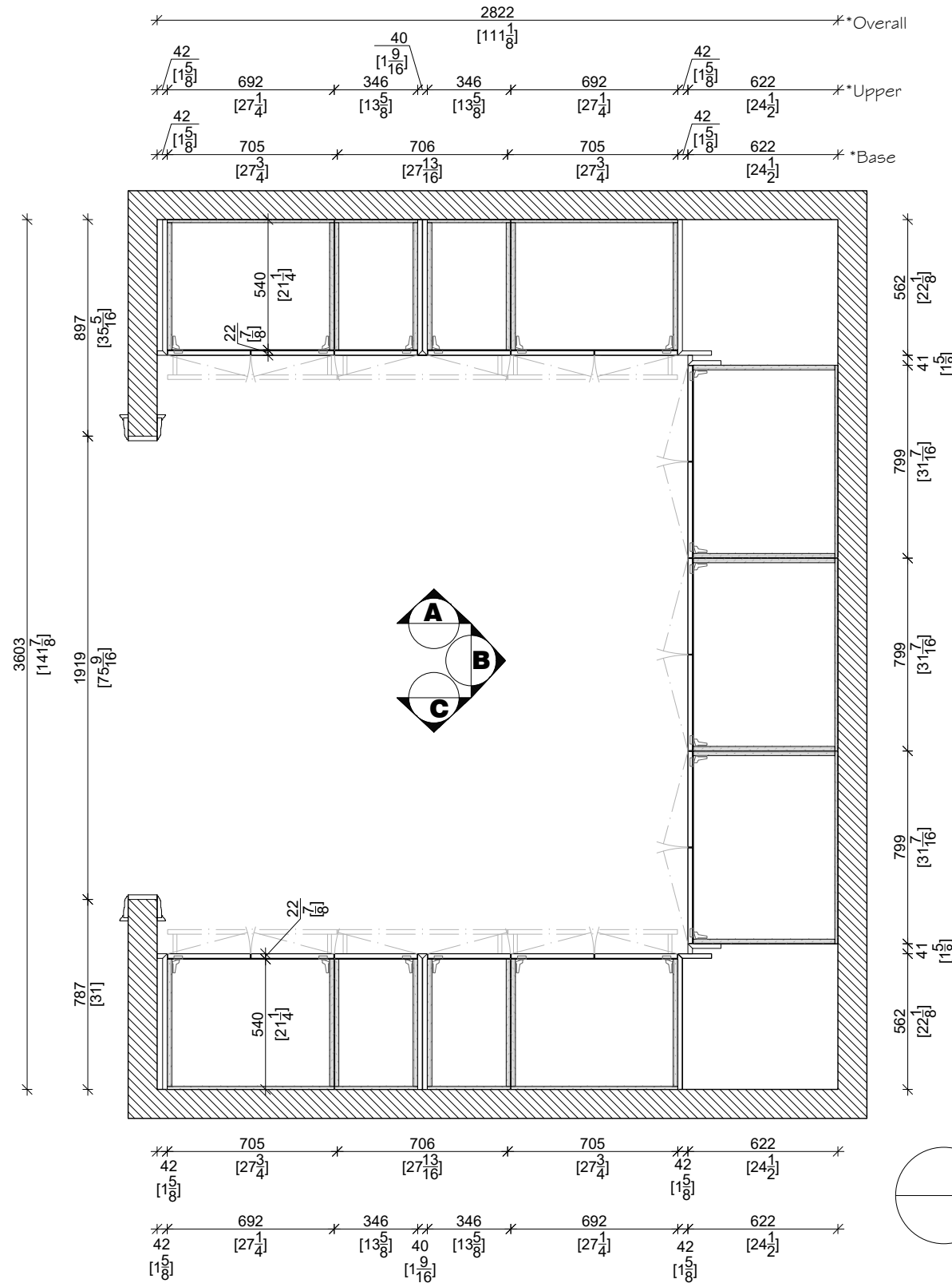

I have read and fully understand this Autocad drawing. The design, finishes, colour and dimensions are correct. I understand that this signed Autocad drawing will supersede any verbal or other written agreements. I understand once this drawing is signed and sent to production, no more changes may be made.

<b>Approval :</b>	Page 13 of 47
<b>Date :</b>	Master W.I.C



**PLAN - MASTER W.I.C**  
SCALE: 1:25

**NOTE:**

-  \*AGT PET
-  \*603HIGH GLOSS METALLIC ELM
-  \*AGT PET
-  \*BLACK 723 SOFT TOUCH

Copyright © 2022 Pure Kitchens. All rights reserved.

<b>Job #</b>	PK24-001
<b>Client :</b>	Anthony Macri-Sixth Avenue Homes
<b>Address :</b>	35 Botfield Ave, Etobicoke, ON M9B 4E2
<b>Tel :</b>	416-278-9937
<b>Email :</b>	-
<b>Date :</b>	Oct. 30, 2023

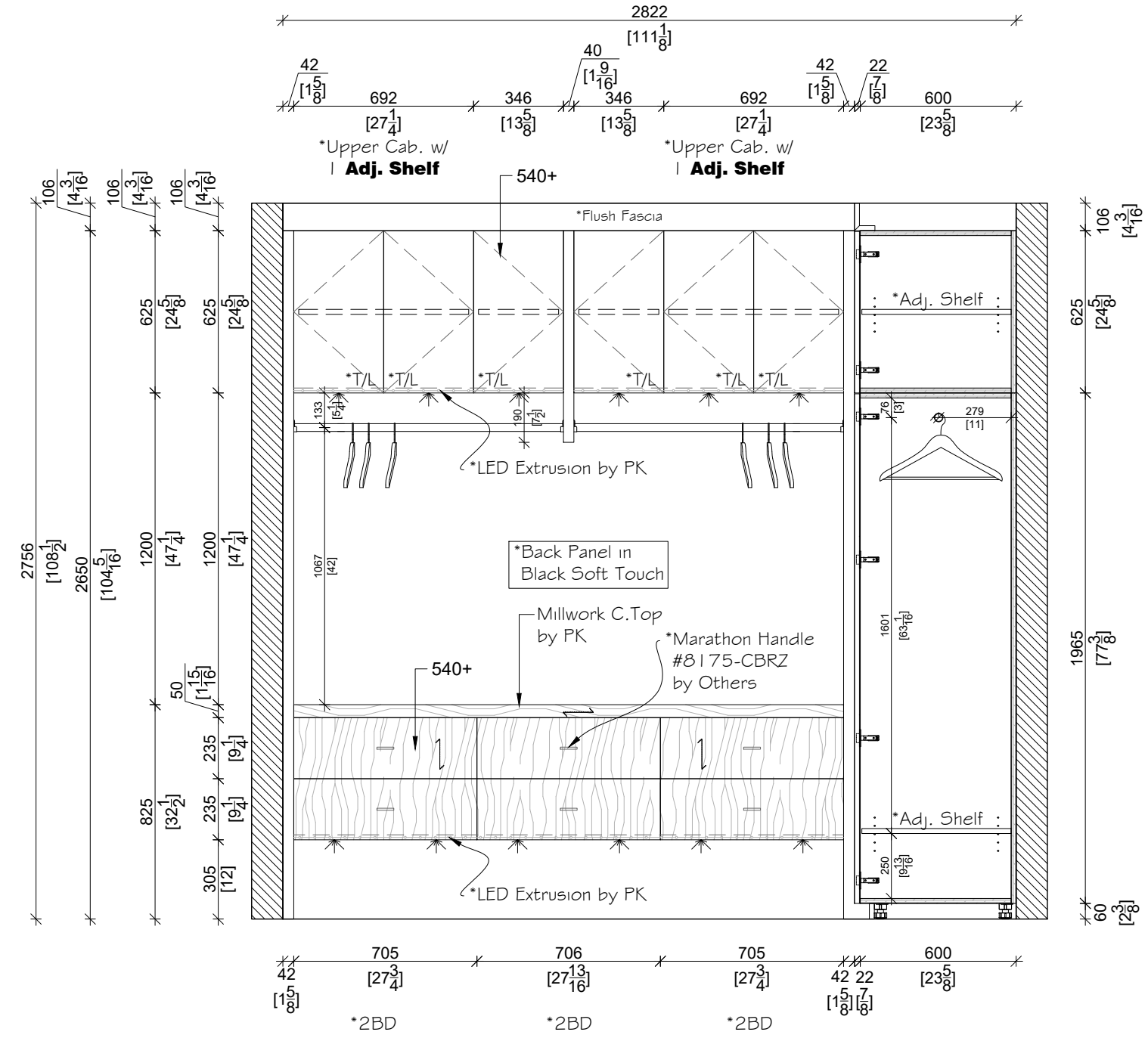

**ELEVATION A**  
 SCALE: 1:22

TOP ALIGNMENT		
<b>Bulkhead Height(B.H.)</b>		275.6 cm
<b>Cabinet Mounting Height</b>		265.0 cm
<b>Project</b>	Base & Counter	Upper & Pantry
<b>Const.</b>	Frameless	Frameless
<b>Door</b>	Slab	Slab
<b>Species</b>	AGT PET	AGT PET
<b>Grain Dir.</b>	-	As per drawing
<b>Finish</b>	Prefinished	Prefinished
<b>Colour</b>	Black 723 Soft Touch	603 HG Metallic Elm

<b>Interior</b>	3/4" Tafisa L203 Black TFL	
<b>End Panel</b>	Flat	
<b>Edge Tape</b>	match Exterior	
<b>Drw.&amp;Slide</b>	Grass Vionaro (Graphite) & Dynapro	
<b>Toe Kick</b>	6cm Legs	
<b>Handles</b>	Marathon #8175-CBRZ BY OTHERS Marathon #8175-160-CBRZ BY OTHERS	

CROWN & TRIMS	
<b>CM #</b>	Flush Fascia
<b>Bead</b>	-
<b>Baseboard #</b>	-
<b>Light Valance</b>	-

GLASS/MIRROR & METAL	
<b>Mirror</b>	Textured (Code: -)
<b>Aluminum Frame</b>	-
<b>Metal Cladding</b>	-
<b>Light Extrusion</b>	JOYO Light LS1613 by PK

Drawn & Reviewed By	#	Revision Date
Jack X	1	2023/12/20 J.X.
Signature	Date	
Donny Di V	2	2024/01/17 J.X.
Signature	Date	
Checked & Approved By Designer	3	
Jaelyn Van M	4	
Signature	Date	
	5	1:22
		Scale:

I have read and fully understand this Autocad drawing. The design, finishes, colour and dimensions are correct. I understand that this signed Autocad drawing will supersede any verbal or other written agreements. I understand once this drawing is signed and sent to production, no more changes may be made.

<b>Approval :</b>	Page 14 of 47
<b>Date :</b>	Master W.I.C

**NOTE:**

-  \*AGT PET  
\*603HIGH GLOSS  
METALLIC ELM
-  \*AGT PET  
\*BLACK 723  
SOFT TOUCH

Copyright © 2022 Pure Kitchens. All rights reserved.

<b>Job #</b>	PK24-001
<b>Client :</b>	Anthony Macri-Sixth Avenue Homes
<b>Address :</b>	35 Botfield Ave, Etobicoke, ON M9B 4E2
<b>Tel :</b>	416-278-9937
<b>Email :</b>	-
<b>Date :</b>	Oct. 30, 2023

**TOP ALIGNMENT**

<b>Bulkhead Height(B.H.)</b>	275.6 cm	
<b>Cabinet Mounting Height</b>	265.0 cm	
<b>Project</b>	Base & Counter	Upper & Pantry
<b>Const.</b>	Frameless	Frameless
<b>Door</b>	Slab	Slab
<b>Species</b>	AGT PET	AGT PET
<b>Grain Dir.</b>	-	As per drawing
<b>Finish</b>	Prefinished	Prefinished
<b>Colour</b>	Black 723 Soft Touch	603 HG Metallic Elm

<b>Interior</b>	3/4" Tafisa L203 Black TFL	
<b>End Panel</b>	Flat	
<b>Edge Tape</b>	match Exterior	
<b>Drw.&amp;Slide</b>	Grass Vionaro (Graphite) & Dynapro	
<b>Toe Kick</b>	6cm Legs	
<b>Handles</b>	Marathon #8175-CBRZ BY OTHERS Marathon #8175-160-CBRZ BY OTHERS	

**CROWN & TRIMS**

<b>CM #</b>	Flush Fascia
<b>Bead</b>	-
<b>Baseboard #</b>	-
<b>Light Valance</b>	-

**GLASS/MIRROR & METAL**

<b>Mirror</b>	Textured (Code: -)
<b>Aluminum Frame</b>	-
<b>Metal Cladding</b>	-
<b>Light Extrusion</b>	JOYO Light LS1613 by PK

Drawn & Reviewed By	#	Revision Date
Jack X	1	2023/12/20 J.X.
Signature _____ Date _____	2	2024/01/17 J.X.
Donny Di V	3	
Signature _____ Date _____	4	
Checked & Approved By Designer	5	1:22
Jaelyn Van M		
Signature _____ Date _____		<b>Scale:</b>

I have read and fully understand this Autocad drawing. The design, finishes, colour and dimensions are correct. I understand that this signed Autocad drawing will supersede any verbal or other written agreements. I understand once this drawing is signed and sent to production, no more changes may be made.

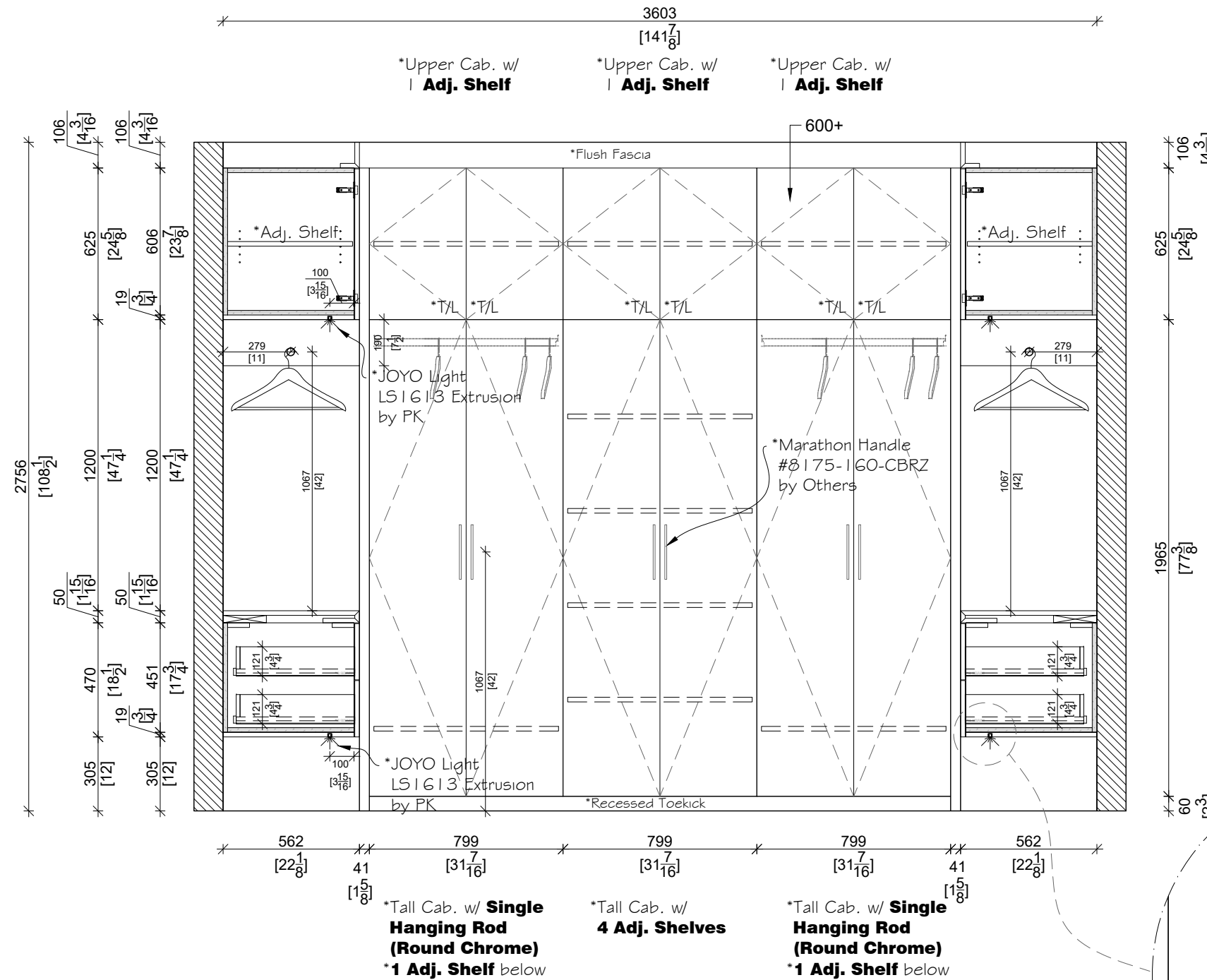

<b>Approval :</b>	Page 15 of 47
<b>Date :</b>	Master W.I.C

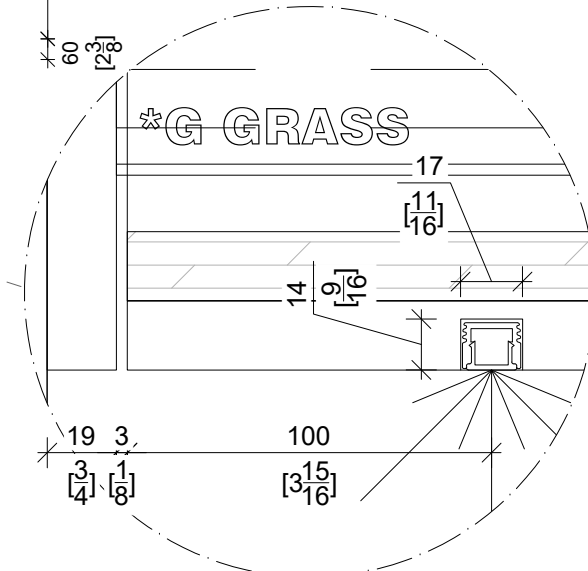

**ELEVATION B**  
SCALE: 1:22



**NOTE:**

-  \*AGT PET  
\*603HIGH GLOSS METALLIC ELM
-  \*AGT PET  
\*BLACK 723 SOFT TOUCH

Copyright © 2022 Pure Kitchens. All rights reserved.

<b>Job #</b>	PK24-001
<b>Client :</b>	Anthony Macri-Sixth Avenue Homes
<b>Address :</b>	35 Botfield Ave, Etobicoke, ON M9B 4E2
<b>Tel :</b>	416-278-9937
<b>Email :</b>	-
<b>Date :</b>	Oct. 30, 2023

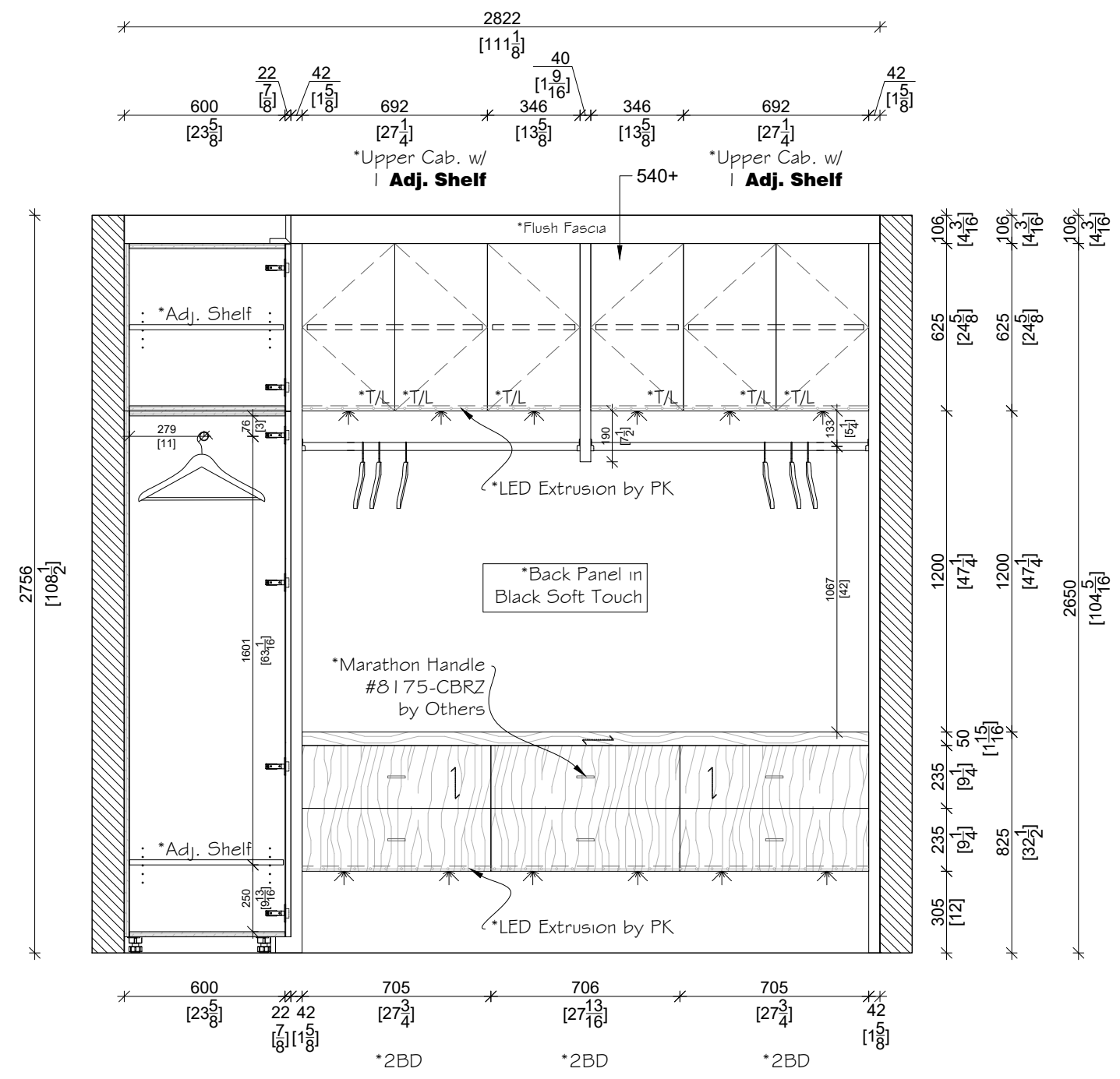

**ELEVATION C**  
 SCALE: 1:22

TOP ALIGNMENT		
<b>Bulkhead Height(B.H.)</b>		275.6 cm
<b>Cabinet Mounting Height</b>		265.0 cm
<b>Project</b>	Base & Counter	Upper & Pantry
<b>Const.</b>	Frameless	Frameless
<b>Door</b>	Slab	Slab
<b>Species</b>	AGT PET	AGT PET
<b>Grain Dir.</b>	-	As per drawing
<b>Finish</b>	Prefinished	Prefinished
<b>Colour</b>	Black 723 Soft Touch	603 HG Metallic Elm

<b>Interior</b>	3/4" Tafisa L203 Black TFL	
<b>End Panel</b>	Flat	
<b>Edge Tape</b>	match Exterior	
<b>Drw.&amp;Slide</b>	Grass Vionaro (Graphite) & Dynapro	
<b>Toe Kick</b>	6cm Legs	
<b>Handles</b>	Marathon #8175-CBRZ BY OTHERS Marathon #8175-160-CBRZ BY OTHERS	

CROWN & TRIMS	
<b>CM #</b>	Flush Fascia
<b>Bead</b>	-
<b>Baseboard #</b>	-
<b>Light Valance</b>	-

GLASS/MIRROR & METAL	
<b>Mirror</b>	Textured (Code: -)
<b>Aluminum Frame</b>	-
<b>Metal Cladding</b>	-
<b>Light Extrusion</b>	JOYO Light LS1613 by PK

Drawn & Reviewed By	#	Revision Date
Jack X	1	2023/12/20 J.X.
Signature _____ Date _____	2	2024/01/17 J.X.
Donny Di V	3	
Signature _____ Date _____	4	
Checked & Approved By Designer	5	1:22
Jaelyn Van M		
Signature _____ Date _____		Scale:

I have read and fully understand this Autocad drawing. The design, finishes, colour and dimensions are correct. I understand that this signed Autocad drawing will supersede any verbal or other written agreements. I understand once this drawing is signed and sent to production, no more changes may be made.



**NOTE:**

- \*U - SHAPED DRAWERS TO BE MADE AFTER PLUMBING HOOK-UP
- \*SINK SPEC. TO BE CONFIRMED

Copyright © 2022 Pure Kitchens. All rights reserved.

<b>Job #</b>	PK24-001
<b>Client :</b>	Anthony Macri-Sixth Avenue Homes
<b>Address :</b>	35 Botfield Ave, Etobicoke, ON M9B 4E2
<b>Tel :</b>	416-278-9937
<b>Email :</b>	-
<b>Date :</b>	Oct. 30, 2023

**TOP ALIGNMENT**

<b>Bulkhead Height(B.H.)</b>	280.0 cm
<b>Cabinet Mounting Height</b>	73.6 cm

<b>Project</b>	Master Vanity
<b>Const.</b>	Frameless
<b>Door</b>	Reeded
<b>Species</b>	MDF
<b>Grain Dir.</b>	-
<b>Finish</b>	Prefinished
<b>Colour</b>	To Match Black 723 Soft Touch
<b>Interior</b>	3/4" Tafisa L203 Black TFL
<b>End Panel</b>	Flat
<b>Edge Tape</b>	match Exterior
<b>Drw.&amp;Slide</b>	Grass Vionaro (Graphite) & Dynapro
<b>Toe Kick</b>	6cm Legs
<b>Handles</b>	Gola J Shape & C Shape (Matte Black)

**CROWN & TRIMS**

<b>CM #</b>	Flush Fascia
<b>Bead</b>	-
<b>Baseboard #</b>	-
<b>Light Valance</b>	-

**GLASS/MIRROR & METAL**

<b>Mirror</b>	Textured (Code: -)
<b>Aluminum Frame</b>	-
<b>Metal Cladding</b>	-
<b>Light Extrusion</b>	-

Drawn & Reviewed By	#	Revision Date
Jack X	1	2023/12/22 J.X.
Signature _____ Date _____	2	2024/01/17 J.X.
Check By	3	
Donny Di V	4	
Signature _____ Date _____	5	1:22
Checked & Approved By Designer	Scale:	
Jaclyn Van M		
Signature _____ Date _____		

I have read and fully understand this Autocad drawing. The design, finishes, colour and dimensions are correct. I understand that this signed Autocad drawing will supersede any verbal or other written agreements. I understand once this drawing is signed and sent to production, no more changes may be made.

<b>Approval :</b>	Page 17 of 47
<b>Date :</b>	Master Vanity

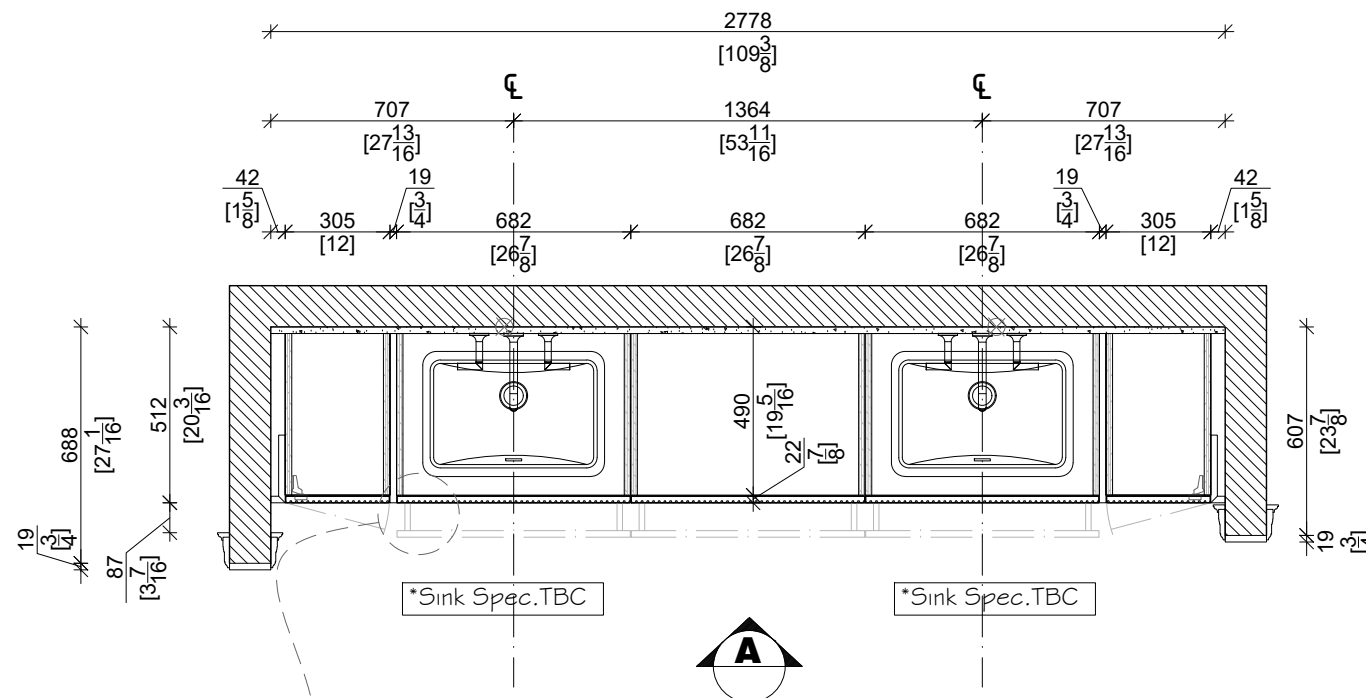

**PLAN - MASTER VANITY**

SCALE: 1:22

☒ \*Existing Drainage

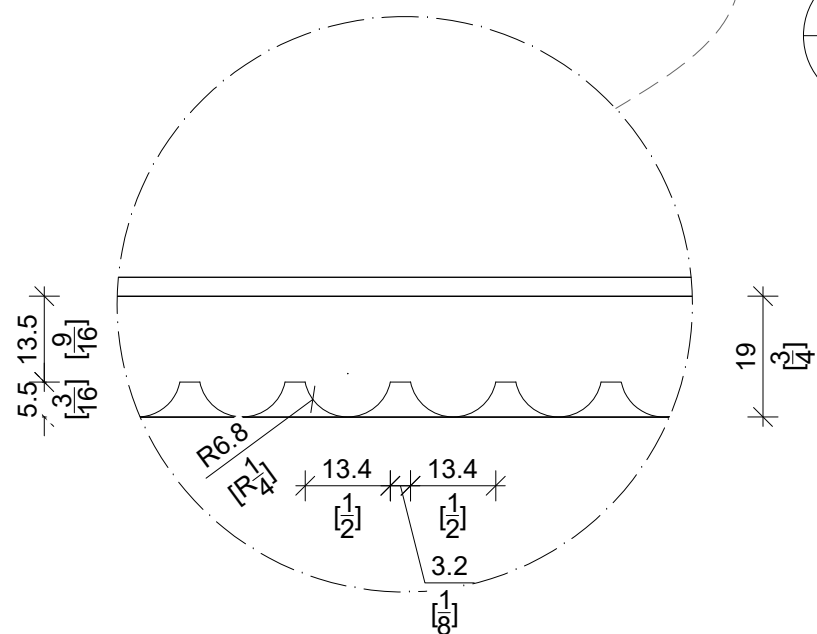

**NOTE:**

Copyright © 2022 Pure Kitchens. All rights reserved.

<b>Job #</b>	PK24-001
<b>Client :</b>	Anthony Macri-Sixth Avenue Homes
<b>Address :</b>	35 Botfield Ave, Etobicoke, ON M9B 4E2
<b>Tel :</b>	416-278-9937
<b>Email :</b>	-
<b>Date :</b>	Oct. 30, 2023

**TOP ALIGNMENT**

<b>Bulkhead Height(B.H.)</b>	280.0 cm
<b>Cabinet Mounting Height</b>	73.6 cm
<b>Project</b>	Master Vanity
<b>Const.</b>	Frameless
<b>Door</b>	Reeded
<b>Species</b>	MDF
<b>Grain Dir.</b>	-
<b>Finish</b>	Prefinished
<b>Colour</b>	To Match Black 723 Soft Touch
<b>Interior</b>	3/4" Tafisa L203 Black TFL
<b>End Panel</b>	Flat
<b>Edge Tape</b>	match Exterior
<b>Drw.&amp;Slide</b>	Grass Vionaro (Graphite) & Dynapro
<b>Toe Kick</b>	6cm Legs
<b>Handles</b>	Gola J Shape & C Shape (Matte Black)

**CROWN & TRIMS**

<b>CM #</b>	Flush Fascia
<b>Bead</b>	-
<b>Baseboard #</b>	-
<b>Light Valance</b>	-

**GLASS/MIRROR & METAL**

<b>Mirror</b>	Textured (Code: -)
<b>Aluminum Frame</b>	-
<b>Metal Cladding</b>	-
<b>Light Extrusion</b>	-

Drawn & Reviewed By	#	Revision Date
Jack X	1	2023/12/22 J.X.
Signature _____ Date _____	2	2024/01/17 J.X.
Donny Di V	3	
Signature _____ Date _____	4	
Checked & Approved By Designer	5	1:22
Jaclyn Van M		
Signature _____ Date _____		<b>Scale:</b>

I have read and fully understand this Autocad drawing. The design, finishes, colour and dimensions are correct. I understand that this signed Autocad drawing will supersede any verbal or other written agreements. I understand once this drawing is signed and sent to production, no more changes may be made.

<b>Approval :</b>	Page 18 of 47
<b>Date :</b>	Master Vanity

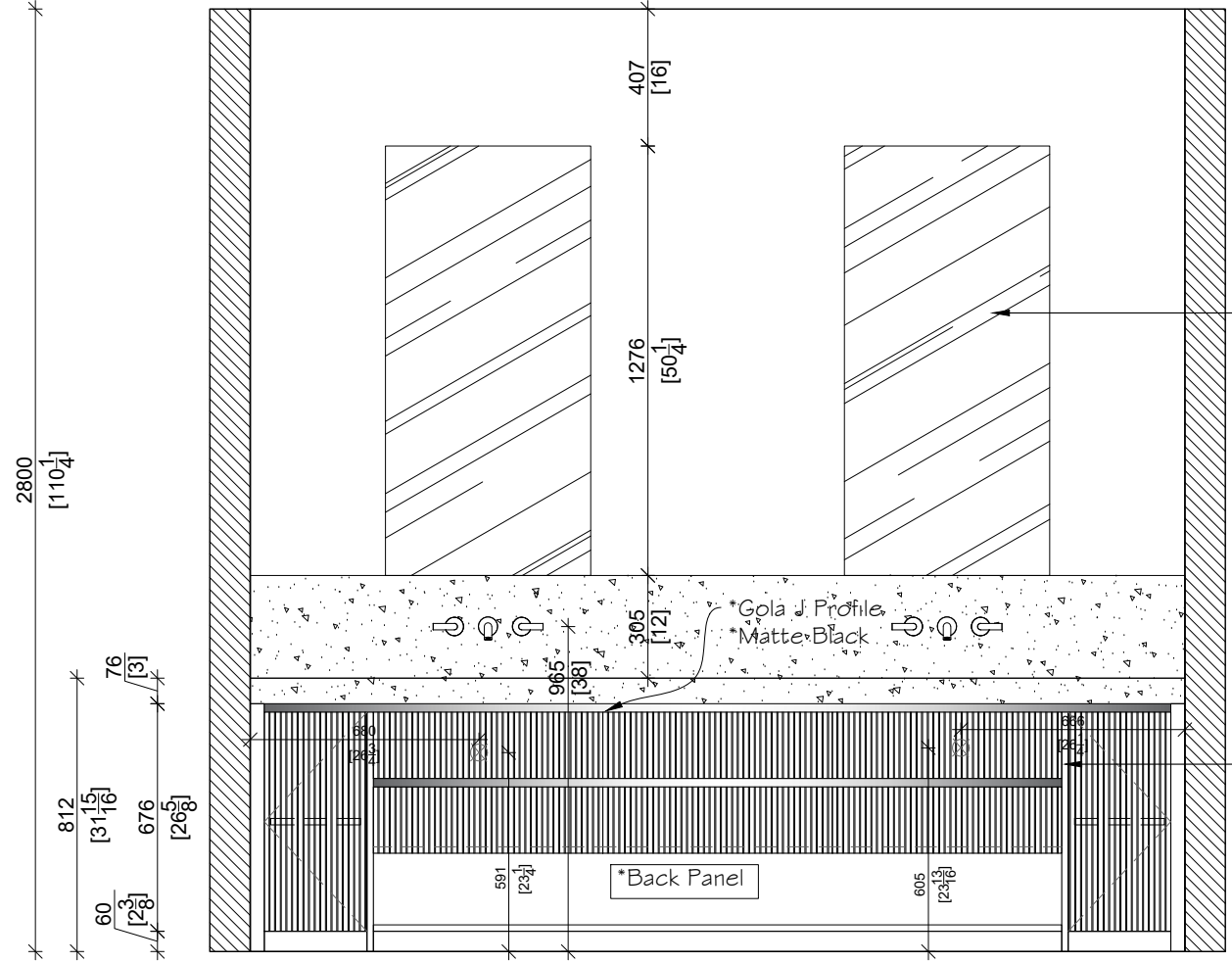
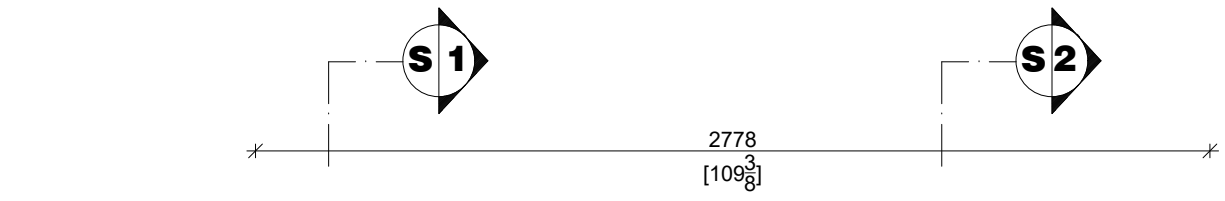

\*Mirror by Others

\*Gable to be notched for Gola L Shape

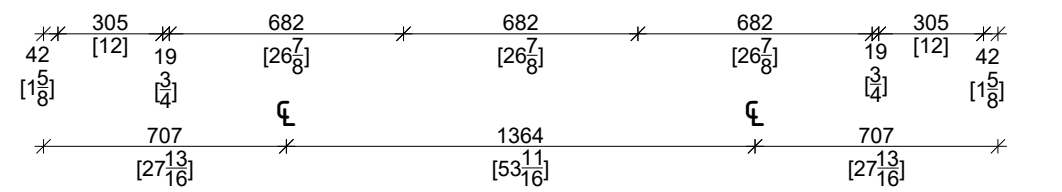

\*Base Cab. w/ 1 Adj. Shelf  
\*Sink Base 2 U Shape Drawers  
\*2BD  
\*Sink Base 2 U Shape Drawers  
\*Base Cab. w/ 1 Adj. Shelf

**ELEVATION A**  
SCALE: 1:22

**S1-SECTION**  
SCALE: 1:22

**S2-SECTION**  
SCALE: 1:22